



ELX8-60

User's Guide (CCTV Monitor User)

(v 1.0)

FCC Compliance Statement

Caution : Any changes or modifications in construction of this device which are not expressly approved the party responsible for compliance could void the user's authority to operate the equipment.

NOTE : This equipment has been tested and found to comply with the limits for a Class B digital device, pursuant to part 15 of the FCC Rules. These limits are designed to provide reasonable protection against harmful interference in a residential installation. This equipment generates, uses and can radiate radio frequency energy and, if not installed and used in accordance with the instructions, may cause harmful interference to radio communications, However, there is no guarantee that interference will not occur in a particular installation. If this equipment does cause harmful interference to radio or television reception, which can be determined by turning the equipment off and on, the user is encouraged to try to correct the interference by one or more of the following measures:

- Reorient or relocate the receiving antenna.
- Increase the separation between the equipment and receiver.
- Connect the equipment into an outlet on a circuit different from that to which the receiver is connected.
- Consult the dealer or an experienced radio/TV technician for help.

CAUTION

1. Danger of explosion if battery is incorrectly replaced.
2. Replace only with the same or equivalent type.
3. Dispose of used batteries according to the general recommendations against the environmental pollution.

Important Notice

1. Do not place heavy objects on the top of the ELX8-60.
2. ELX8-60 is not weatherproof. In case of outdoor use, equip a weatherproof case to protect ELX8-60 from water, moisture, or temperature (higher or lower than specifications). To clean the ELX8-60, gently wipe the outside with a clean dry cloth.
3. Be sure to use a DC adapter that is provided by Rugged CCTV Connecting ELX8-60 directly to an AC current will cause electric damages to ELX8-60.
4. Be careful not to drop the ELX8-60. Physical shocks may harm the product. In addition, be sure the ELX8-60 is secured after installation.
5. ELX8-60 is made of metal. Therefore you can hurt human beings if you throw it to them or hit on them. When installing ELX8-60, be cautious to locate on safe places where children are unreachable.
6. If ELX8-60 does not operate properly, please contact the closest Rugged CCTV distributor for after sales service. Tampering or disassembling the product will void the warranty.
7. Security surveillance laws may differ for each country. Therefore, please contact the local region first to avoid any surveillance law violations.

TABLE OF CONTENTS

- OVERVIEW6**
- 1. Introduction6
- 2. Product Description8
 - 2.1. Front Panel8
 - 2.2. Rear Panel9
 - 2.3. Installation Summary 10
- Basic Configuration11**
- 3. Monitoring11
 - 3.1. Viewing basic screen (quad-split).....11
 - 3.2. Viewing single full screen11
 - 3.3. Viewing multi screen11
 - 3.4. Viewing all channels with sequence mode 12
 - 3.5. Viewing an alarm triggered channel 13
 - 3.6. Viewing images with Digital Zoom 13
 - 3.7. Viewing with connected PTZ13
 - 3.8. Using Relay15
 - 3.9. Using Screen Lock 15
- 4. Playback16
 - 4.1. Playback via various mode..... 16
 - 4.1.1. Playback via basic screen (full screen) 16
 - 4.1.2. Playback via quad-split screen 16
 - 4.1.3. Playback ch5 to ch8 via quad-split screen 16
 - 4.1.4. Playback with Digital Zoom 16
 - 4.1.5. Various playback modes 16
 - 4.2. Using Search Mode 18
 - 4.3. Copy / Backup / Delete Data Manager 19
 - 4.3.1. Copy Data19
 - 4.3.2. Backup Data 20
 - 4.3.3. Delete Data 21
- 5. Configuration 22
 - 5.1. Quick Setup22
 - 5.1.1. Date/Time..... 22
 - 5.1.2. Recording..... 25

5.2. Camera.....	27
5.3. Normal Rec.....	30
5.4. Alarm Rec.....	33
5.5. Relay	35
5.6. Monitor.....	36
5.7. System	37
5.7.1. Audio.....	37
5.7.2. Text.....	38
5.7.3. Time Schedule.....	40
5.7.4. Special Time.....	41
5.7.5. Security	42
5.7.6. Disk Setup	43
5.7.7. Network.....	44
5.7.8. Serial Setup.....	51
5.7.9. Miscellaneous	52
5.8. Utility.....	54
5.8.1. Disk Manager	55
Advanced Configuration	57
6. Connecting External Device.....	57
6.1. Using Text Device	57
6.1.1. Setting at Text menu.....	57
6.1.2. Setting at Serial Setup's RS232 menu	58
6.1.3. Setting at Alarm Rec. menu.....	58
6.1.4. Setting at Normal Rec. menu.....	59
6.2. Using Keyboard.....	60
6.2.1. Setting at Serial Setup's RS232 menu.....	60
6.2.2. Setting at Serial Setup's PTZ menu.....	60
APPENDIX	61
#1. Technical Specification	62
#2. Utilizing IP Addresses on Local Network.....	65
#2.1 Introduction	65
#2.2 IP construction and Network class	65
#2.3 C-class Network.....	66

OVERVIEW

1. Introduction

ELX8-60 supports 8 analog video channels. Video, Audio, and Text Event-Logs are digitized and stored on two internal hard-drives. Using a 'Proprietary Wavelet Algorithm,' average file size is 1-5KB while still maintaining clarity high enough for facial-recognition. In addition, Wavelet-compressed images are impossible to manipulate

Due to our proprietary Wavelet Algorithm, the ELX8-60 processes analog video into crisp, clear, and court-admissible pictures that are up to 500% smaller than comparable JPEG images. With this efficiency, ELX8-60 records over 30 days on a 200GB hard disk drive when recording 4 channels at the speed of 10ips per channel. ELX8-60 also allows users to record and playback audio for one channel.

Setting-up ELX8-60 is as easy as setting up a VCR. ELX8-60 starts to record as soon as power is supplied and CCTV cameras are connected. ELX8-60 offers an easy setup, as well as advanced menus. With 'Quick Setup', ELX8-60 can be setup and begin recording in as little as 5 minutes. The default settings offer quality and efficiency without the hassle of confusing menus.

Equipped with (2) IEEE 1394 ports (Fire-Wire) and (3) USB ports, ELX8-60 can expand its recording capacity to up to 4TB easily. For easy backup, Windows (FAT32) formatted HDD is compatible with ELX8-60. Simply back up the desired data and connect the HDD to your PC to review critical images.

Key features

- 8 analog video channels
- 1 channel audio recording & playback
- Recording, Playback, Back-up images and Networking at the same time (Quadplex)
- Total 60 ips recording speed
- Total 240 ips display speed
- Displaying live and recorded images on PC as well as CCTV Monitor
- Built-in hardware Quad Splitter for analog video
- Built-in software multiplexer for all 8 live monitoring channels
(1 / 4 / 9Ch Mode on CCTV Monitor as well as PC)
- Maximum 4TB storage capacity (IEEE 1394 for external HDD)
- Various configuration with recording and playback conditions
- Intelligent file system for managing event triggered video data
- ATM/POS transaction information text recording and search with corresponding video
- 4 pairs of sensor inputs and alarm outputs
- Built-in hardware motion detection with search function (64-division comparison)
- Back-up with IEEE 1394(FiWi).
- PTZ Control (Preset support) via RS 232 and RS 485/RS422
- User-friendly 32bit True-colored Graphic OSD Menu
- Dynamic IP (DHCP, Floating IP) support (when xDSL and Cable Modem are used)
- Wavelet compression: 1-5KB (Average file size with standard image quality)
- Embedded Linux OS for excellent stability and reliability
- IR remote controller (User controls PTZ with remote controller)
- DVR Manager (User Interface of PC) is to be listed with 32 units of ELX8-60 on a program
(256chnnels(32sets of ELX8-60 x 8 channels) are controllable through a program)

2. Product Description

2.1. Front Panel

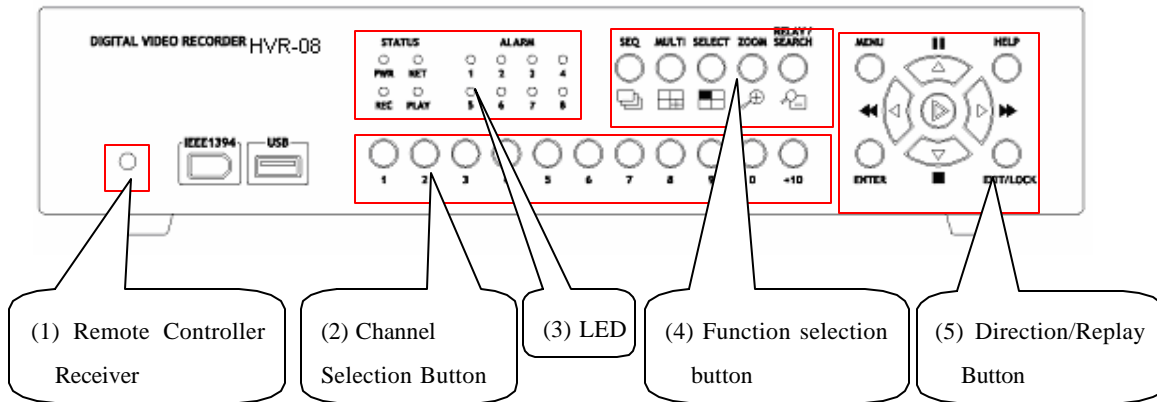

(1) Remote Controller Receiver

(2) Channel Selection Button

- To select video input channel in monitoring and playback mode

(3) LED

- **PWR** : Displays power status. When lit, power is supplied .

- **NET** : Displays the status of Ethernet connection and rate of communication. When blinking, data being transmitted or received over the Ethernet.

- **REC** : Displays image recording status. The rate of blinking indicates the speed of recording. (i.e. When blinking rapidly, ELX8-60 is recording at a high rate; when blinking slower, the ELX8-60 is recording at a lower rate.)

- **PLAY** : Displays playback status. The rate of blinking indicates the speed of playback. (i.e. When blinking rapidly, ELX8-60 is playing back at a high rate; when blinking slower, the ELX8-60 is playing back at a lower rate.)

(4) Function selection button

- **SEQ** : To select Sequencing Mode. ELX8-60 will automatically display all connected channels in successive order.

- **MULTI**: To select the multi-channel display (4 -9-divided screen).

- **SELECT** : To select video channel for PTZ control in Monitor mode and for Copy/Backup/Delete in Playback mode

- **ZOOM**: To activate the digital zoom (single channel mode only).

- **RELAY/SEARCH** : To search the recorded image in Playback mode or to toggle the Relay On/Off function in Monitoring mode

- (5) Direction/Replaying Button
- **MENU**: To set PTZ and access Configuration menu.
- **ENTER**: To enter and confirm the selected menu.
- **HELP** : To change the image information display (Date, Transfer speed, etc).
- **EXIT/LOCK** : To exit form the selected menu or lock current screen.
- **Arrow key**: Replay function or to move inside the Configuration menu.

2.2. Rear Panel

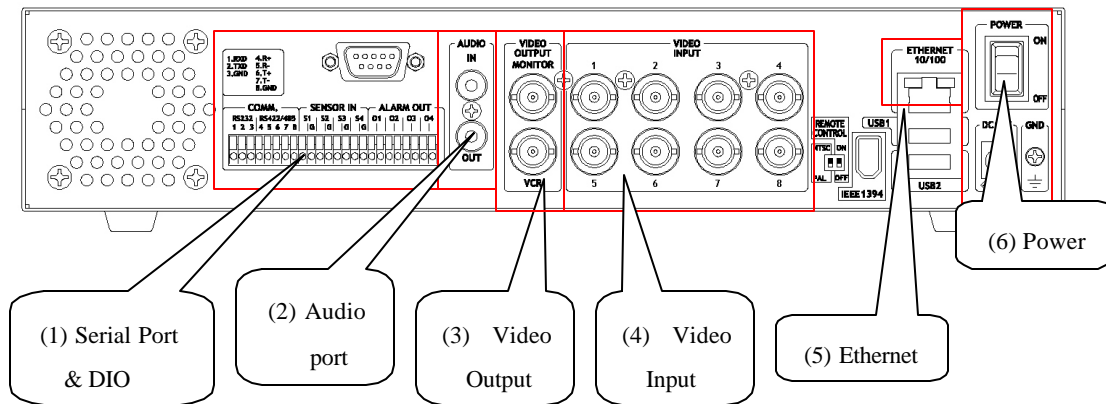

- (1) Serial Port & DIO
 - **Serial** : RS232 9Pin D-Sub Connector & RS232/422/485 terminal block
 - **Sensor In** : 4 sensor inputs
 - **Relay Out** : 4 Alarm Relay outputs
- (2) Audio port
 - 1 audio input & 1 output
- (3) Video Output
 - 1 monitor output & 1 VCR output
- (4) Video Input
 - 8 video inputs
- (5) Ethernet
- (6) Power

2.3. Installation Summary

- Connect Camera
- Connect Monitor
- Connect Ethernet.

(This is optional to view image on remote location)

- Connect Audio
- Connect Power & Run

Basic Configuration

3. Monitoring

Once power is supplied to ELX8-60, default quad-split monitoring mode (analog channels 1~4) will be displayed. The following steps apply for all ELX8-60's monitoring menus.

<Button control>

- Press the [MULTI] button on the front panel of ELX8-60 to change the split configuration (4, 9).
- For sequence mode, press the [SEQ] button on the front panel of ELX8-60. To configure the sequential cycle, access the "Monitor" tab of Configuration Menu.

3.1. Viewing basic screen (quad-split)

- Insert AC cord's plug in a wall outlet and turn the power switch "On."
 - LED is on and ELX8-60 starts booting.
 - After start-up, the basic screen (quad-split) is displayed.
- * If user password is set, a dialogue box for entering the password will appear.



3.2. Viewing single full screen

- Press the desired channel number button on the front panel of ELX8-60.
- To return to the multi-view screen, press the [MULTI] button.

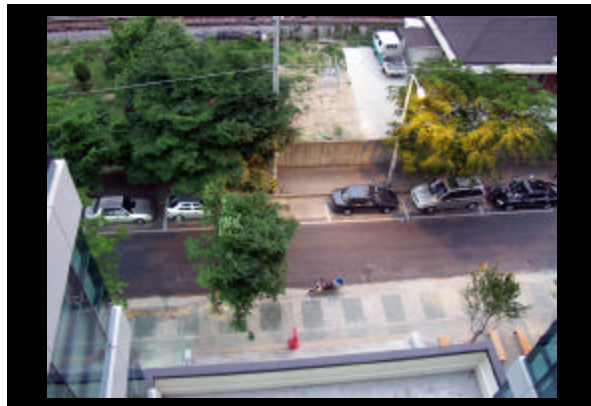

3.3. Viewing multi screen

- Press the [MULTI] button to view several channels simultaneously.

- To change the split screen configuration, press the [MULTI] button. 4, or 9 split screens will be displayed.

3.4. Viewing all channels with sequence mode

- All channels can be viewed in successive order automatically using the [SEQ] button.
- Press the [MENU] button on the front panel to set-up the sequential cycle. (The default value is 3 seconds per channel for display.)
- Select "Monitor" tab of Configuration menu.
- Move to "Configuration" below "Monitor" using the down arrow button on ELX8-60 front panel.
- Select "Seq. Switching(sec)" and press the [ENTER] button.
- Set any value between 1 and 60 seconds.

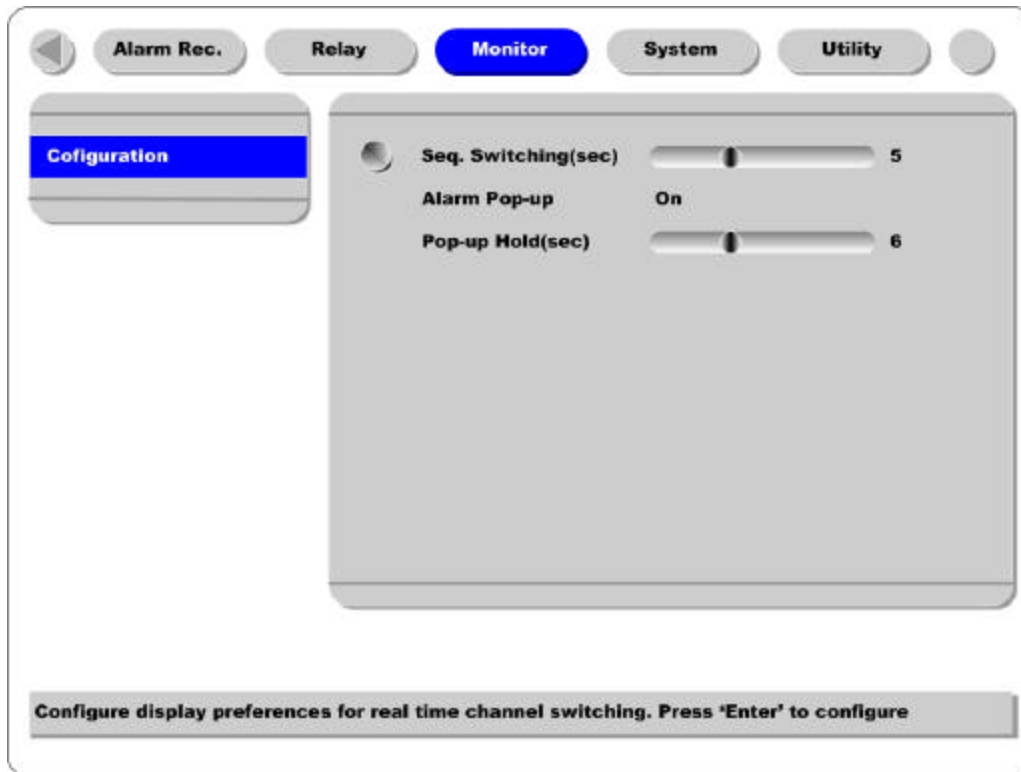

- Then press the [SEQ] button from any viewer mode.

< Note >

Sequence mode can run only when connected and activated cameras are more than split screen. With single full screen mode, activated cameras should be two or more. With quad-split screen mode, there should be five or more activated cameras. With 9split screen mode, there should be ten or more activated cameras. (SEQUENCE MODE ONLY SUPPORTS 4 AND 9 SPLIT SCREENS). Channel order cannot be changed. For example, with quad-split screen, Ch. 1/2/3/4 are displayed and then Ch.5/6/7/8 are displayed.

- To end sequence function, press the [SEQ] button.

3.5. Viewing an alarm triggered channel

- When an alarm is triggered, the related channel will pop-up full screen automatically.
- Set 'Alarm Pop-up Screen' function to "On" in "Configuration" under the "Monitor" tab, and set the display duration in "Pop-up Hold (sec)"
- If more than one channel is triggered by an alarm, the related channels will be displayed simultaneously in a split-screen. In order to move current screen, press any button.

3.6. Viewing images with Digital Zoom

- In Single Full Screen mode, live and recorded images can be expanded using the Digital Zoom feature.
- To enable the digital zoom, press the [ZOOM] button.
- Digital Zoom will expand the image to twice its normal size.
- Default location of the digital zoom is in the center of screen. The zoom box can be moved each 10th step to left and right and 4th step up and down.
- To move the zoom box, use the [Arrow] button.
- To cancel the zoom box, press the [ZOOM] button once more.

3.7. Viewing with connected PTZ

- Pan/Tilt/Zoom (PTZ) devices can be controlled through the ELX8-60 when a PTZ device is connected and properly configured under "Serial Setup."
- While in Monitor mode, press the [SELECT] button.
- Channel selection icon will be displayed.
- Move the icon to the channel to control with the [Arrow] button.
- Press the [MENU] button.
- PTZ menu (Pan/Tilt, Zoom/Focus, Load Preset, Save Preset) will appear
- Press the [ENTER] button after selecting the desired function.



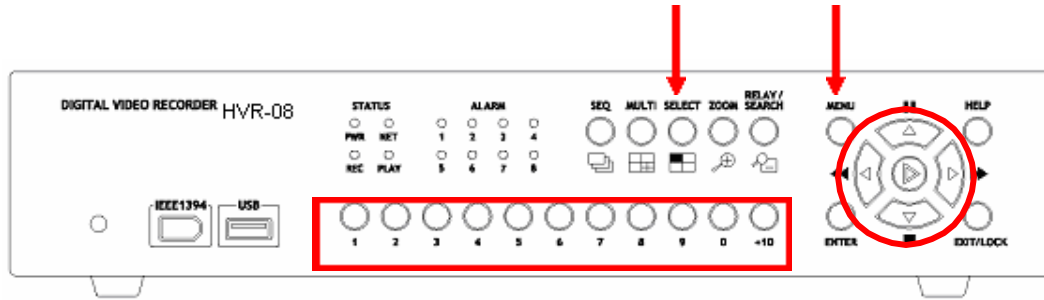

Pan/Tilt Control

To control Pan and Tilt during live image monitoring mode.

- Press the [SELECT] button. Move the “Select” icon to the desired channel.
- Press the [MENU] button.
- Select ‘Pan/Tilt’ from the PTZ Menu.
- Control pan and tilt function using the up, down, left and right arrows.

Zoom/Focus Control

To control Zoom and Focus during live image monitoring mode.

- Press the [SELECT] button. Move the “Select” icon to the desired channel.
- Press the [MENU] button.
- Select ‘Zoom/Focus’ from the PTZ Menu.
- Control zoom and focus functions using the up, down, left and right arrows of front panel.

Load Preset

To load preset for dome camera during live monitoring mode.

- Press the [SELECT] button. Move the “Select” icon to the desired channel.
- Press the [MENU] button.
- Select ‘Load Preset’ from the PTZ Menu.
- Press number button for desired preset on the front panel.

Save Preset

To set a new preset point for dome camera during live monitoring mode

- Move dome camera to the desired position using the ‘Pan/Tilt’ and ‘Zoom/Focus’ menus.
- Press the [SELECT] button.
- Press the [MENU] button.
- Select ‘Save Preset’ from the PTZ Menu
- Designate a number for the preset position by pressing a number button on the front panel.

3.8. Using Relay

To set relay on/off. (ELX8-60 supports four relay outputs.)

- Press the [SEARCH/RELAY] button.
- The icon of “Relay On” shows.
- Press the relay number button between 1 and 4, and then the related relay out signal will be transmitted.
- In order to set relay off, press the [SEARCH/RELAY] button again.
- Then “Relay On” shows because relay keeps being set as on.
- Press the [SEARCH/RELAY] button again, and then the icon of “Relay Off” will show.
- Press the relay a number button to set off.

3.9. Using Screen Lock

To set screen lock.

- For this function, user password should be set at first.
- If pressing the [EXIT/LOCK] button for 2~3 seconds, lock mode will run with showing “Screen Locked” message.
- If lock mode runs, any function button will not be operated.
- In order to cancel lock mode, user password should be entered.

4. Playback

To replay recorded images in full screen or quad split screen modes.

4.1. Playback via various mode

4.1.1. Playback via basic screen (full screen)

- Press the Play [] button during monitoring mode.
- Play [] button will begin playback of the last 30 seconds of recorded video at 1X speed.

< Note >

When pressing the play button in multi-monitoring mode, channel 1 is always the channel displayed. More specifically, images recorded on Channel 1 during the last 30 seconds are always displayed. However pressing the playback button in single-channel monitoring mode, will display the selected channel. To display another channel, press the corresponding number button on the front of ELX8-60.

4.1.2. Playback via quad-split screen

- Press the [MULTI] button during basic (single-channel) playback mode.
- Channels 1 to 4 will be displayed in the quad-split screen.
- To display a single channel, press the corresponding number button on the front of the ELX8-60.

4.1.3. Playback ch5 to ch8 via quad-split screen

- Press the [SELECT] button in quad-split mode.
- Select a split position.
- If selecting a channel number, the related image is played in the position.

4.1.4. Playback with Digital Zoom

- Press the [ZOOM] button during the basic (single-channel) playback mode.
- Digital Zoom will expand the image to twice its normal size.
- Default location of the digital zoom is in the center of screen. The zoom box can be moved each 10th step to left and right and 4th step up and down.
- To move the zoom box, use the [Arrow] button.
- To cancel the zoom box, press the [ZOOM] button once more.

4.1.5. Various playback modes

- (PLAY) : To begin playback mode and replay at 1x speed. After pressing PAUSE (), PLAY will advance recorded images frame by frame.

- (STOP) : To stop replaying
- (PAUSE) : To pause replaying
- (FAST FORWARD) : Each press of the button will increase playback speed gradually (x1, x2, x4, x8, x16)
- (FAST REWIND) : Each press of the button will increase playback speed gradually (x1, x2, x4, x8, x16)
- STEP FORWARD : Pressing [, PLAY] or [, FAST FORWARD] button from PAUSE status, will replay image frame by frame. In order to go back to normal playback mode, press [, STOP] button then press [, PLAY] or [, FAST FORWARD] button.
- STEP REWIND : Pressing [, FAST REWIND] button from PAUSE status, will replay image frame by frame. In order to go back to normal playback mode, press [, STOP] button then press [, PLAY] or [, FAST FORWARD] button.

4.2. Using Search Mode

Search Mode is used to search and play specific data directly during playback mode. Data can be searched by specific Time and Date or by the Event Log browser.



<Button control>

- Press the [SEARCH] button during playback mode.
- Search for data by entering Date/Time or by selecting an event from the Event Log browser.
- Press the [ENTER] button after entering the desired Date/Time or selecting Event from log.
- The selected images will begin to playback.
- To exit from search mode, press the [EXIT] button.

<Note> Using Log Browser

1. To move to the previous/next page, press the "Left" or "Right" buttons.
2. To move to previous log entry, press the "Up" button.
3. To move to next log entry, press the "Down" button.

4.3. Copy / Backup / Delete Data Manager

To copy/backup/delete the recorded data. This menu is activated during playback mode.

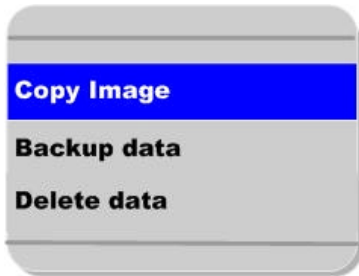

- Press the [SELECT] button and [MENU] button in Playback mode.

4.3.1. Copy Data

To copy a specific data with USB memory stick.

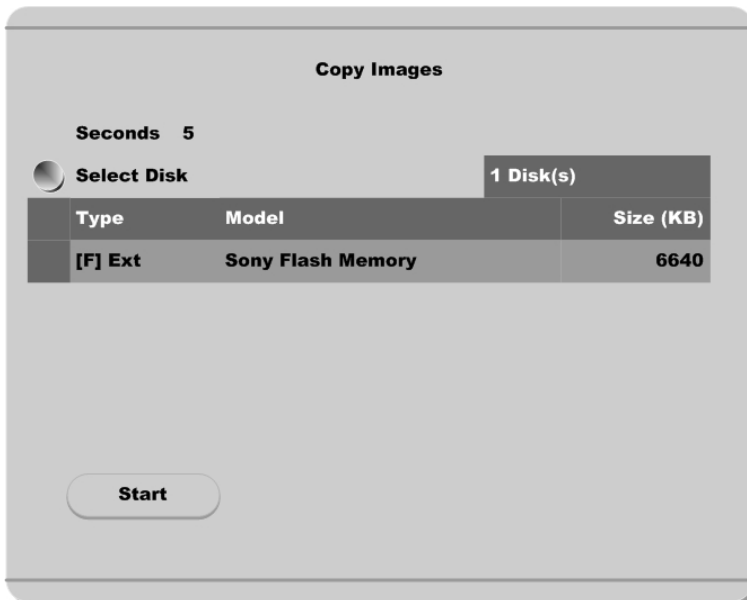

Seconds

To designate copy range between 1 and 60 seconds.

Select Disk

Select copy disk.

4.3.2. Backup Data

Backup Manager

Start Date 2003/04/01 **Time** 10:12

End Date 2003/04/01 **Time** 11:12

Select Disk 1 Disk(s)

	Type	Model	Size (KB)
<input checked="" type="checkbox"/>	Ext	Maxtor 4R08010	80043264

Start

Start Date & Time / End Date & Time

To designate backup range.

Select Disk

To select which storage will be used as backup device. To change the disk status, use the “Disk Manager” menu under the “System” tab.

<Note>

Backup Manager does not support USB devices. Backup Manager will ONLY work with devices connected through IEEE1394 / FireWire ports.

4.3.3. Delete Data

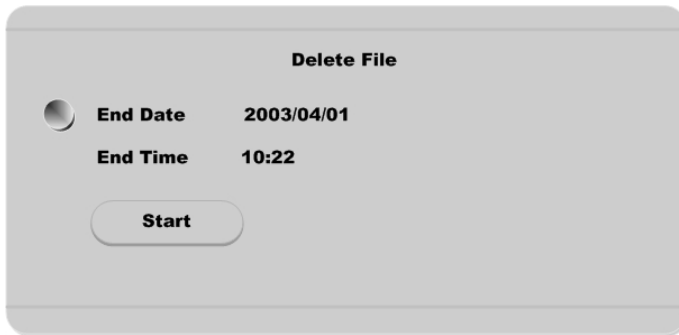

To delete a specific file range from the current recording HDD. This menu does not affect backup disk. The beginning of the range is always the beginning of the recording on the HDD.

5. Configuration

5.1. Quick Setup

There are three menus for recording setup; Quick Setup, Normal Recording, Alarm Recording menu in Configuration Menu. Quick Setup is the easiest set-up, activating all eight analog cameras to record with the same settings and conditions. Normal recording is the standard recording settings and can be customized based on time and channel. Alarm recording is the recording schedule based on alarm conditions (Motion Detection, Sensors, etc.) Also, Quick Setup has time setting menu.

5.1.1. Date/Time

When ELX8-60 is manufactured in factory, time zone will be set as “UTC 00:00 Dublin”.

Set the time to local time zone

Changing ELX8-60 time may cause time conflict with recorded images. In this case, it is strongly recommended to re-format the hard drives after making changes.

< Button control >

- Press [MENU] button on ELX8-60 front panel.
- Move to “Quick Setup” menu (First tab on the Configuration menu).
- Move to “Date/Time” below “Quick Setup” using downward arrow button on ELX8-60 front panel.
- Press the [ENTER] button on ELX8-60 front panel.
- Set time. (The following picture will be displayed when setting time menu)
- In order to access each menu, press [ENTER] button after selecting it with upward/downward arrow button on ELX8-60 front panel.

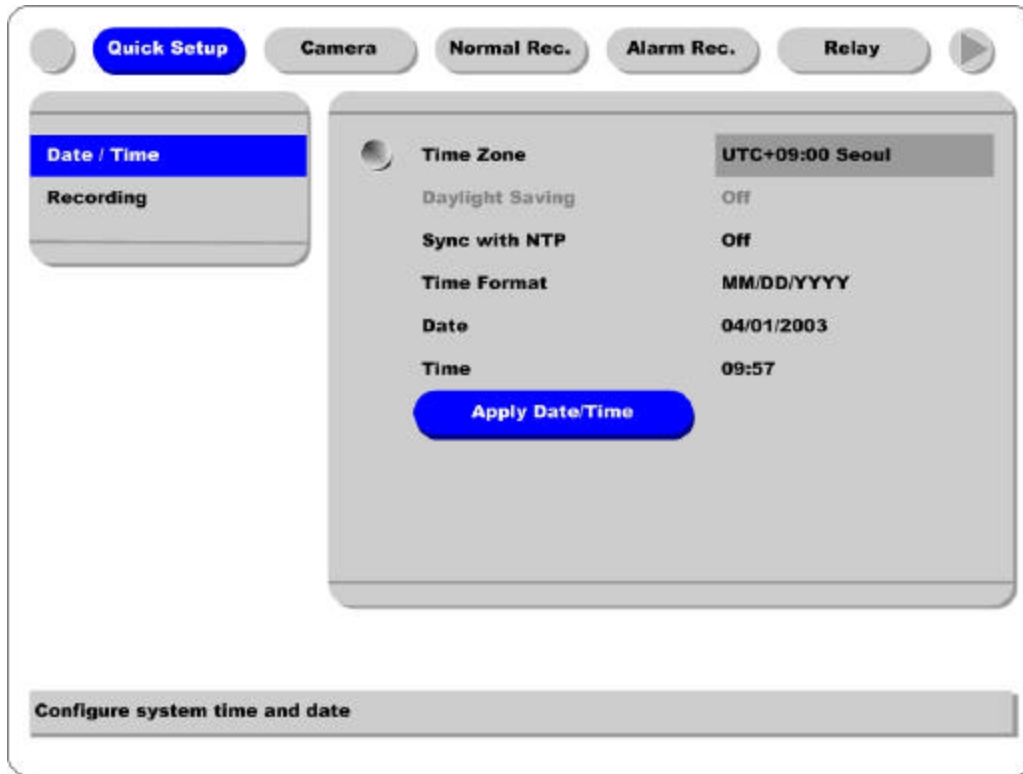

Time Zone

Set the time zone using the left/right arrow button on ELX8-60 front panel. Every time you press left/right arrow button, time zone will change. Select the desired time zone. (To move to the previous menu, press [EXIT] button on ELX8-60 front panel.)

Daylight Saving

The Daylight Savings option is linked to Time Zone. Daylight Savings is only activated for time zones that use Daylight Savings. For example, selecting GMT – 7:00 Arizona will disable the option for Daylight Savings because Daylight Savings is not used in Arizona. This menu is linked with “Time Zone” menu. Namely, if selecting daylight saving area in time zone, this menu will be activated. Oppositely if selected time zone is not enforced, it will not be. It is based on MS Windows. So this menu is for setting whether you apply ON/OFF (with left/right arrow button on ELX8-60 front panel) in daylight saving area.

Sync with NTP

It is to synchronize time with NTP (Network Time Protocol) server. For more detailed information about NTP setting, please refer to the “Network Configuration” (System → Network → NTP Settings).

Time Format

Set the time format between “MM/DD/YYYY” and “YYYY/MM/DD” using the left/right arrow button on ELX8 -60 front panel.

Date/Time

Set date and time. To move from Month to Day to Year/Hour to Minute, use the left/right arrow buttons. To select each month, each day, etc, use the up/down arrow buttons.

Apply Date/Time

Press this button to confirm the above settings. An window will pop-up warning of the possibility of time conflict with recorded images. It is strongly recommended to format the HDD after making changes to the time menu.

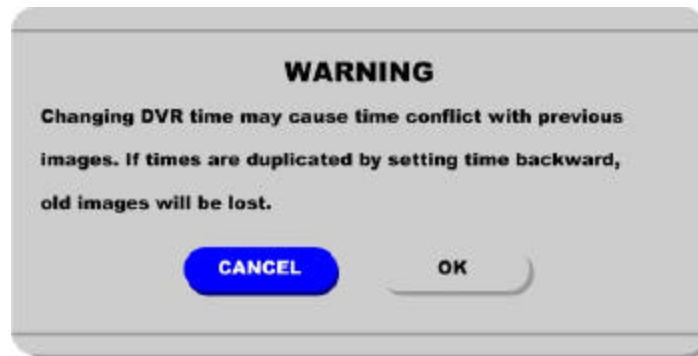
**<Note>**

Most setting values are applied automatically, when exiting from the related menu page. But “Date” & “Time” settings are not applied automatically because they may critically affect the file system of the recorded HDD. To apply Date/Time settings confirm settings with [**Apply Date/Time**] button.

5.1.2. Recording

Its recording values are applied to all 8 channels for all time periods.

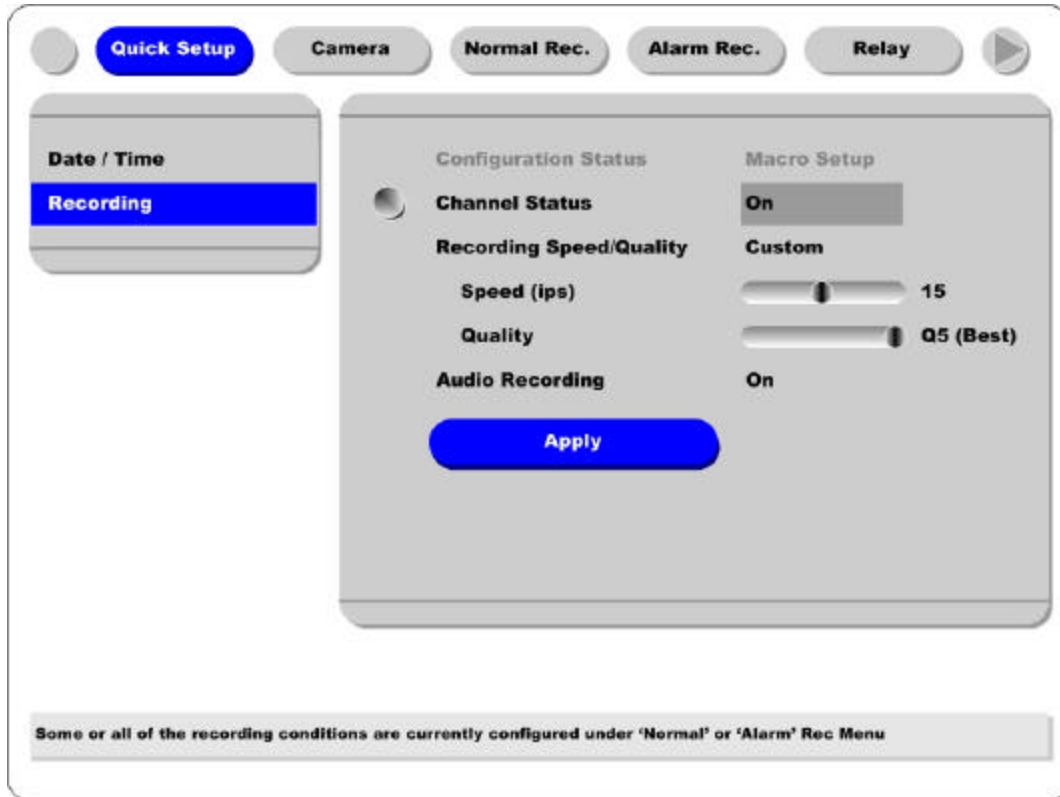

< Button control >

- Press [MENU] button and select to "Recording " from the "Quick Setup" tab.

Configuration Status

Displays the recording set up status. If recording is configured with the Quick Setup, "Macro Setup" will be displayed. If recording is configured with the "Normal" and "Alarm" recording, "Custom Setup" will be displayed.

<Note>

When all 8 analog cameras' normal recording conditions are set identically, the status is marked as 'Macro Setup'. Otherwise, it is marked as 'Custom Setup'.

Channel Status

When "On," all eight analog channels will record based on the Quick Setup settings.

Recording Speed/Quality

There are four conditions (Low/Standard/High/Custom).

All conditions except “Custom” will synchronize “Speed (ips)” and “Quality” automatically; “Low” setting is 1ips/Q5; “Standard” setting is 5ips/Q5; “High” setting is 15ips/Q5. When using the “Custom” setting, Speed (ips) and Quality can be set separately.

Audio Recording

Enables the audio recording feature. If audio is set as “On,” and “Audio Synch with” is set as “All” (in the “Audio” menu under the “System” tab) audio will be available in Playback Mode with all channels .

Apply

Confirms the Quick Setup Recording settings. ELX8-60 will begin recording after pressing the “Apply” button and exiting from the recording menu.

5.2. Camera

This menu is for configuring individual cameras. In Quick Setup, camera status is automatically set as "On." Settings such as Brightness and Contrast can be set for each channel. The values assigned will apply for both monitoring and playback modes.

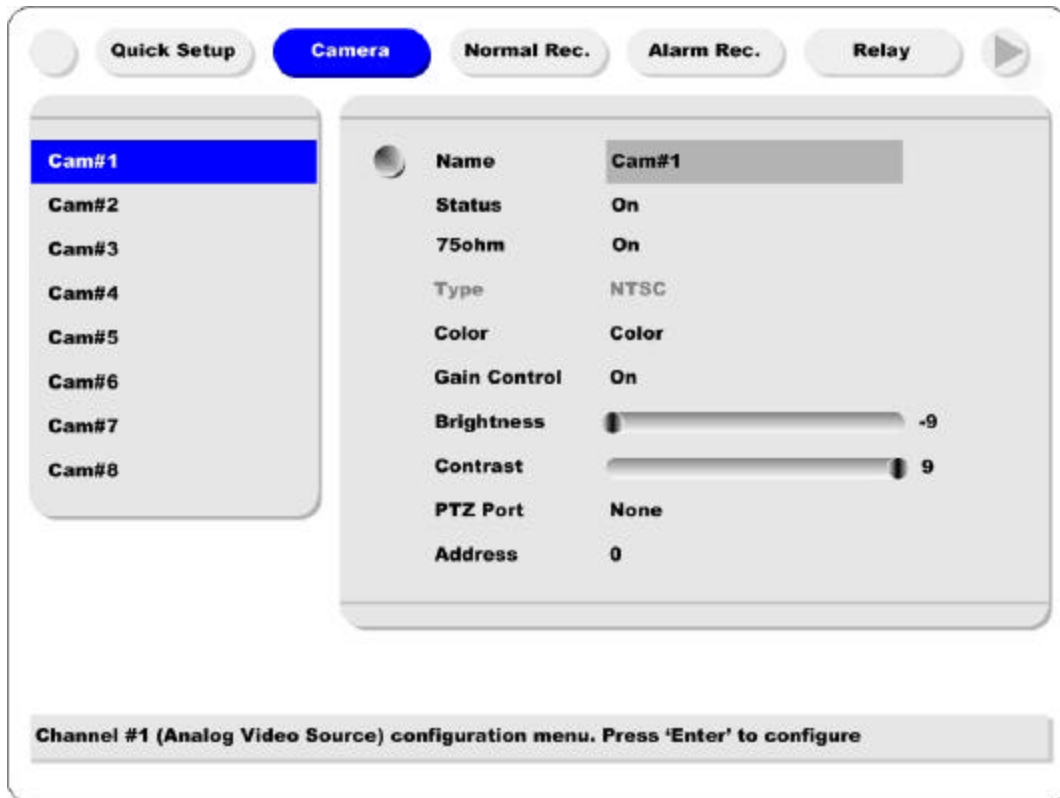

< Button control >

- Press [MENU] button and use the [ARROW] keys to move to each channel below the "Camera" tab.

Name

Assign a customized name to the channel.

Press [ENTER] to open the necessary dialogue box.

<TIP>

When assigning a name to a channel, the following dialogue box will appear. This box is also used later in the system, but the method is always the same.

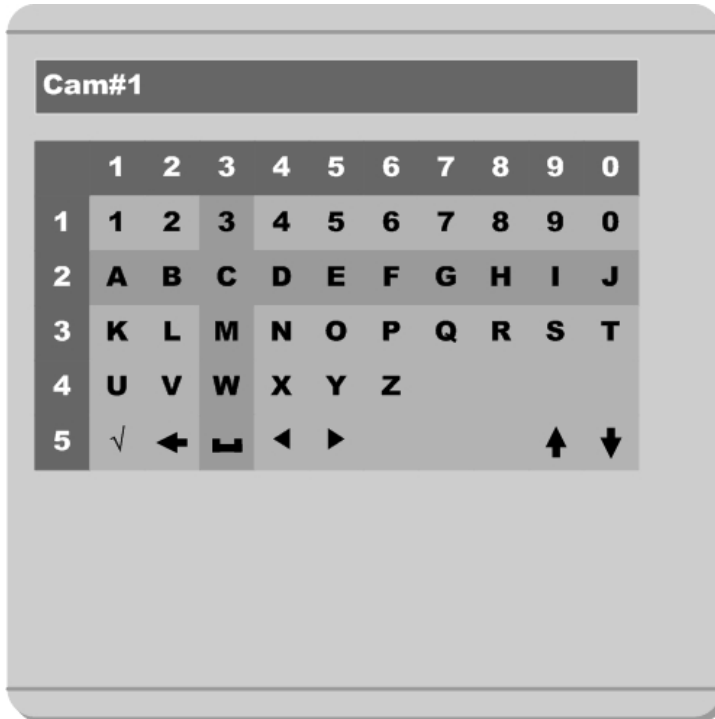

- To select a letter, use the [ARROW] () and () buttons or the number buttons on ELX8-60 front panel; "0" to "9". When using the [ARROW] buttons, use the [PLAY] () button to select each choice.

- The intersection between the horizontal and the vertical bar is the selected choice.

- Press the button to confirm the selected value.

- Or enter the related numbers in order of horizontal/vertical. (For example, in order to select "C", press [3] and [2] button.)

- After setting all values, press the [Exit] button.

- Function Key

✓ : Enter

← : Back Space & delete

⏏ : Space

← : Left

→ : Right

↑ : Previous Code Page

↓ : Next Code Page

Status

Set “On/Off” using the or buttons after pressing the [ENTER] button.

75ohm

Set video input impedance using the or buttons after pressing the [ENTER] button.

Type

Displays the video-input signal. NTSC is the signal used in North America. To toggle the setting, use dip switch on the rear panel of ELX8-60.

Color

Set “Color/ B/W” using the or buttons.

Gain/Brightness/Contrast

Set the value between -9 and +9 using the or buttons.

PTZ Port

Set the value using the or buttons.

Address

Press the [ENTER] button to open the dialogue box.

5.3. Normal Rec.

This menu is for configuring the normal recording settings based on channel and timetable. If this menu is configured Quick Setup, the previous Quick Setup values will be replaced by the Normal Recording settings.



Time Schedule

Each camera can be set to record based on four time schedules; Weekday (Day) / Weekday (Night) / Weekend (Day) / Weekend (Night). Each schedule can be configured under the "System" tab.

< Setting Time Schedule >

In order to set time schedule, move to "System" menu.



Weekday Start/End

Press [ENTER] to access the Time Setting. Set the range for "Weekday" between Monday and Sunday using the or buttons. "Weekend" is set automatically based on "Weekday" range.

Day Start/End

Set the range for "Day" using the up/down buttons. The "Night" range is set automatically based on "Day" range .

Recording Speed/Quality

There are four conditions; Low/Standard/High/Custom.

All conditions except "Custom" synchronize "Speed (ips)" and "Quality" automatically; "Low" setting is 1ips/Q5; "Standard" setting is 5ips/Q5; "High" setting is 15ips/Q5. When using the "Custom" setting, Speed(ips) and Quality can be set separately.

Special Time Recording

This menu is to designate different recording conditions during "Special Times." "Special Time" is designated under the "System" tab.

There are four conditions; Low/Standard/High/Same as above.

< Setting Special Time >

To set "Special Time," move to "System" tab.



Zone1	00:00	to	00:00
Zone2	00:00	to	00:00
Zone3	00:00	to	00:00
Zone4	00:00	to	00:00

Special times are exceptions to normal recording and relay output Schedule. Press 'Enter' to configure

Up to four zones can be designated as "Special Time."

Event Recording

Press the [ENTER] button to access the Event Recording feature. Set "On/Off" using the or buttons.

Event recording condition is set under the "Alarm Recording" tab.

This setting is used to configure the ELX8-60 to record data according to an alarm condition, such as Motion Detection (MD), sensors, etc.

5.4. Alarm Rec.

This menu is to configure for the settings for alarm recording conditions. To activate this schedule, set “Event Recording” under the “Normal Recording” tab to “On.”



MD

Choose from among four sensitivity conditions; Off, Low, Standard, and High.

MD Area

Customize the MD area.

Default value is “Select All”. Select “Custom Area” to remove certain blocks from detecting motion.

Sensor 1/2/3/4

The ELX8-60 will only work with NO (Normal Open) sensors. If sensors are connected, turn each sensor “On.”

< Setting MD Area >

Designate a specific area for motion detection triggered event.

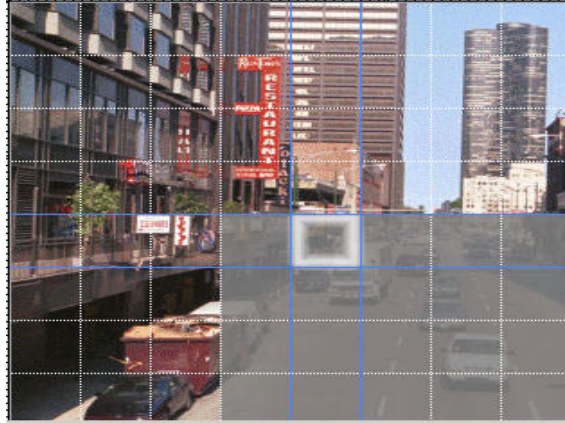

Press the “Custom Area” button, to customize the motion detection area. The area is divided into 64 blocks (8 X 8).

Selected MD area is indicated in dark gray. To remove blocks from motion detection, select the block using the [ARROW] buttons and press the [ENTER] button. Press the [EXIT] button when finished.

Text

In order to display or record text with image, it should be set as “On”. (For more detail setting methods, please refer to “Using Text Data”.)

Recording Speed/Quality

There are four conditions; Low/Standard/High/Custom.

All conditions except “Custom” synchronize “Speed (ips)” and “Quality” automatically; “Low” setting is 1ips/Q5; “Standard” setting is 5ips/Q5; “High” setting is 15ips/Q5. When using the “Custom” setting, Speed (ips) and Quality can be set separately.

Pre Alarm (sec)

Set a value up to 10 seconds to record video Pre-Alarm.

Post Alarm (sec)

Set a value up to 60 seconds to maintain recording conditions Post-Alarm.

5.5. Relay

This menu is to set the relay commands according to each time schedule.

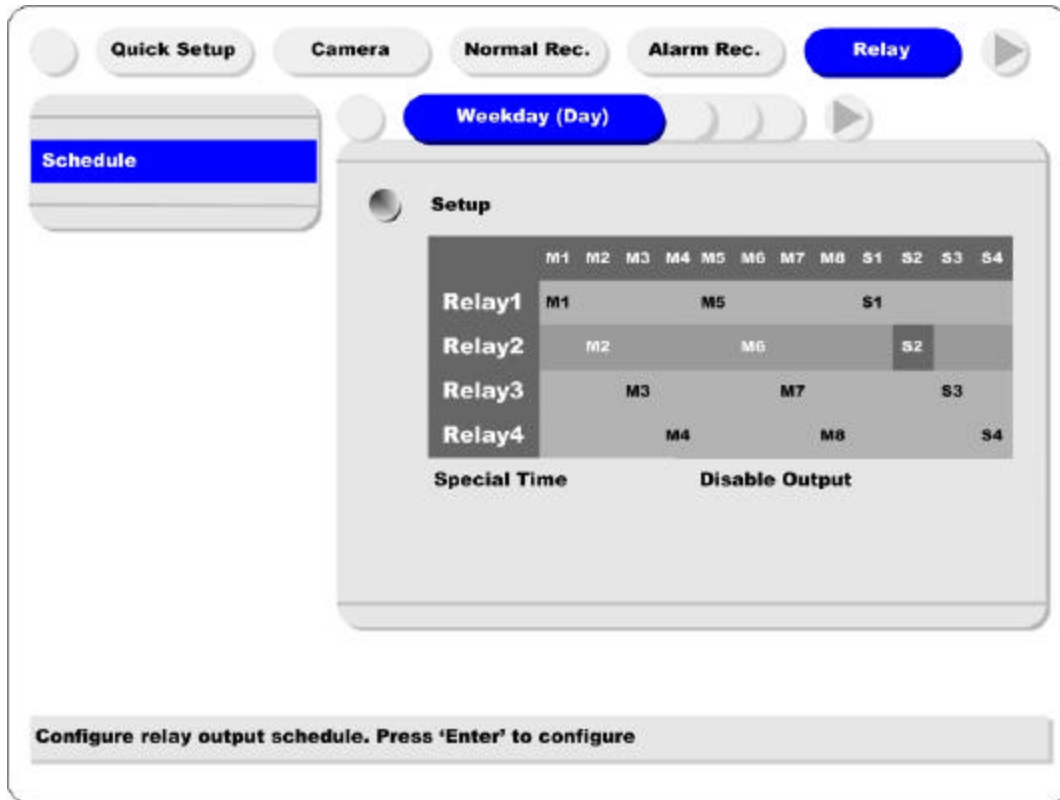

Setup

Alarm triggered events (MD or Sensors) can be set to trigger Relays 1 through 4. When set, the event will trigger the corresponding digital output.

Special Time

Enable “Special Time” to apply the relay schedule to the Special Time Zone.

5.6. Monitor

This menu is to set display image on monitor.

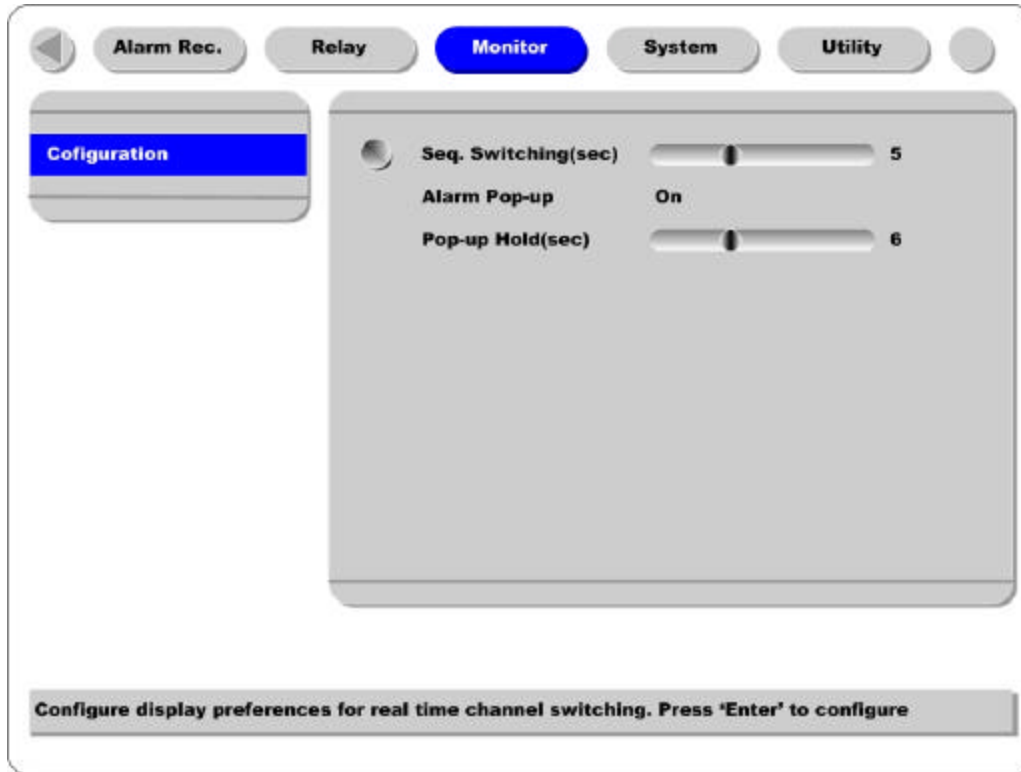

Seq. Switching(sec)

To set sequence time between 1 and 60 seconds.

Alarm Pop-up/Pop-up Hold(sec)

To set alarm pop-up screen. Pop-up duration time can be set between 5 and 10 seconds. If setting as “Keep”, pop-up screen keeps holding. In order to cancel Keep mode, press another channel button.

<Note>

If channel 1 pops up and channel 2 also pops up during pop-up hold time, screen is changed to quad-split screen and channel 1 and 2 are shown. And the pop-up hold time is extended automatically. (Up to eight channels)

5.7. System

5.7.1. Audio

ELX8-60 supports one channel audio input. This single audio channel can be replayed with any connected channel or with all of them.



Recording

Set to “On” using the [ENTER] button and the [ARROW] buttons to record audio.

Audio Gain

Increases or decreases the sensitivity to the audio signal. Can be set between -7 and $+8$.

+20dB

To amplify the audio input signal. Should ONLY be used when using an external microphone.

Sync Audio with

Designate which channel(s) to synchronize audio with during playback.

5.7.2. Text

ELX8-60 can display and playback text data of Access Control/POS/ATM with relevant video.

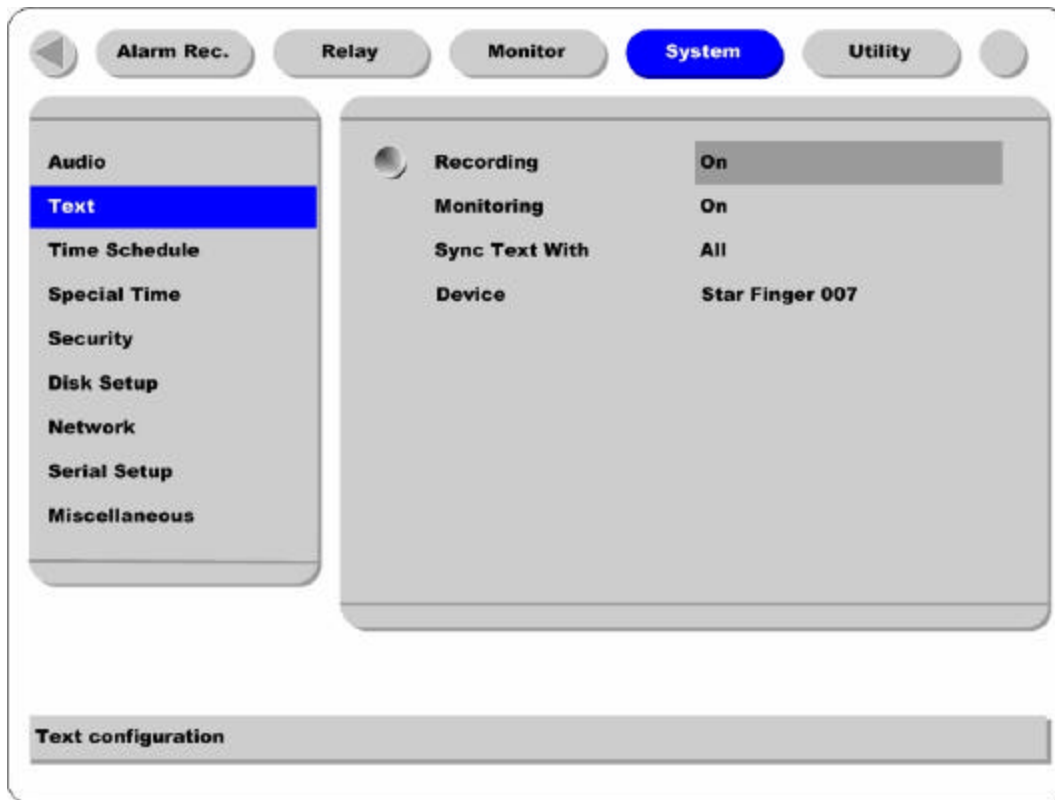

Recording / Monitoring

In order to make ELX8-60 input text data, both of menus should be set as "On".

Sync Text With

To set channel to synchronize with text.

Device

Currently the protocol of Star Finger 007(Access control model) is built in ELX8-60 as text device. Rugged CCTV will keep updating such protocols. When connecting another text device, set as "Manual". Then manual mode setting menu will be displayed. Set each value with referring the manual of connected device.

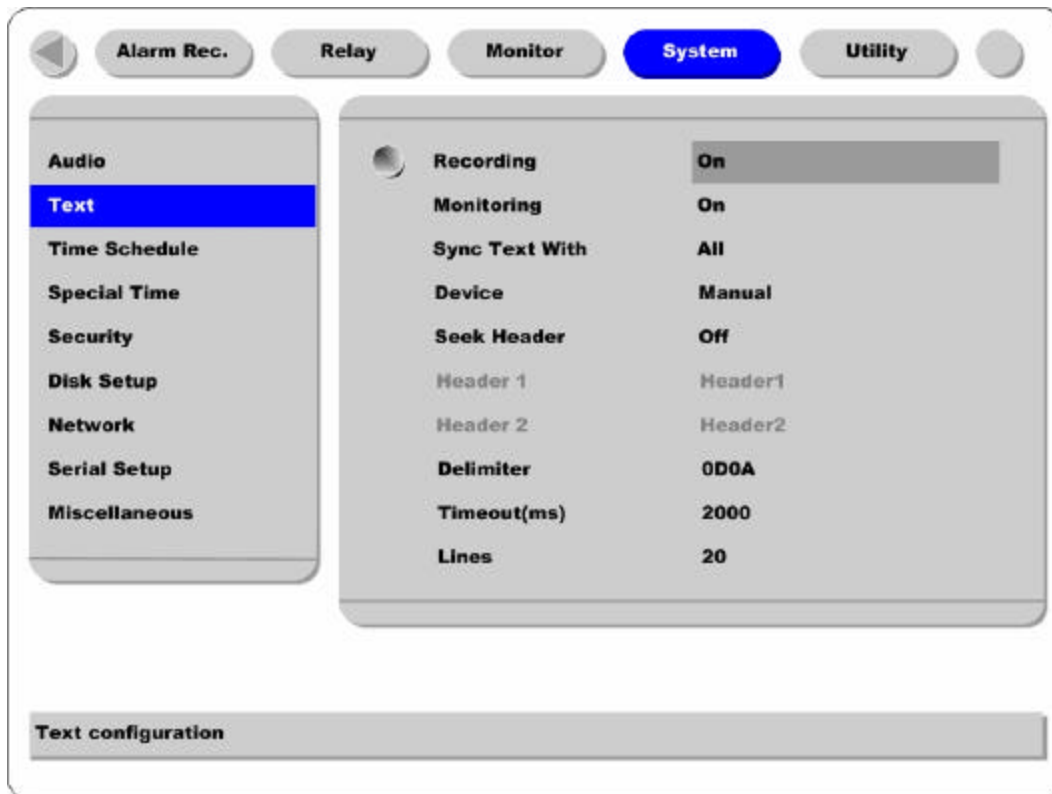

Seek Header

If a protocol is built in ELX8-60 like Star Finger 007, this setting is needless. Otherwise, ELX8-60 can't recognize which parameter value is input to ELX8-60. Namely, all information has starting point and ending point. Header means starting point that is always inserted. So when this header data is transmitted to ELX8-60, ELX8-60 can recognize it as starting point. Two headers can be set maximally.

Delimiter

Because delimiter value may be different, refer to the manual of related device.

Timeout(ms)

The following "Lines" means maximal text line that can be included within a data. However length of each data may be different. Because ELX8-60 can't recognize it automatically, timeout menu is needed. Namely, if specific time passes after ELX8-60 receives the last line, ELX8-60 will regard it as normal data and decide to record.

Lines

To set maximal line of a data.

5.7.3. Time Schedule

To designate *Weekday/Weekend* and *Day/Night*.

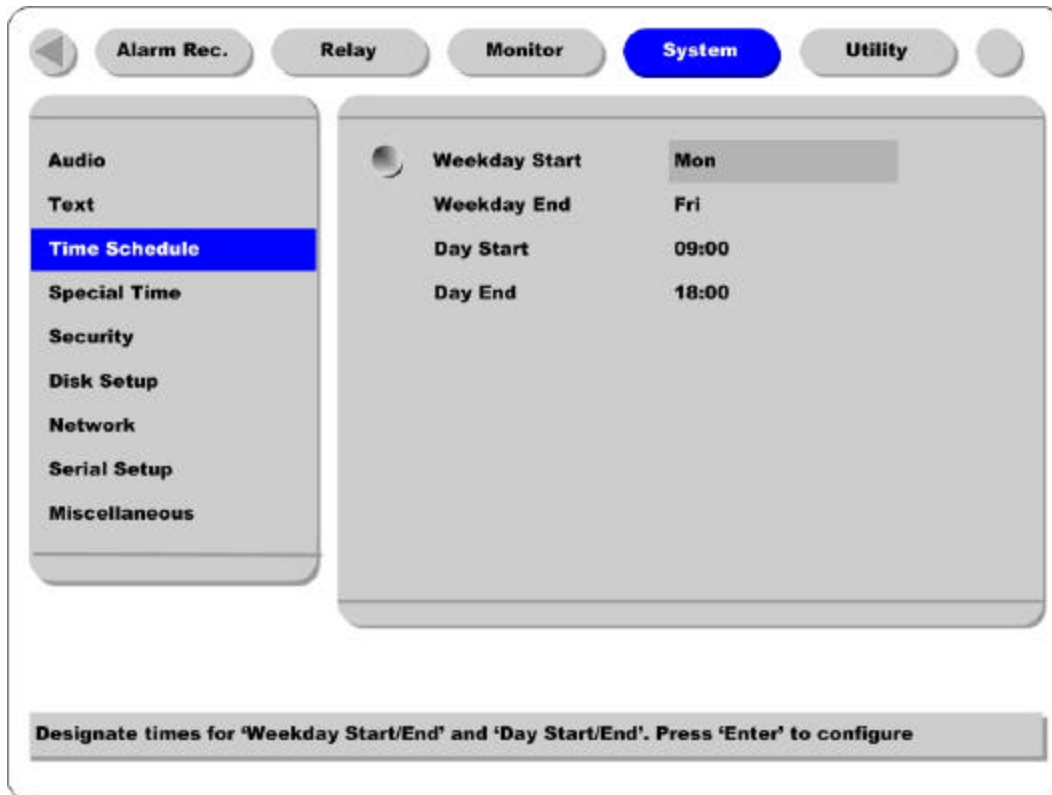

Weekday Start/End

Press [ENTER] to access the Time Setting. Set the range for “Weekday” between Monday and Sunday using the or buttons. “Weekend” is set automatically based on “Weekday” range.

Day Start/End

Set the range for “Day” using the up/down buttons. The “Night” range is set automatically based on “Day” range.

5.7.4. Special Time

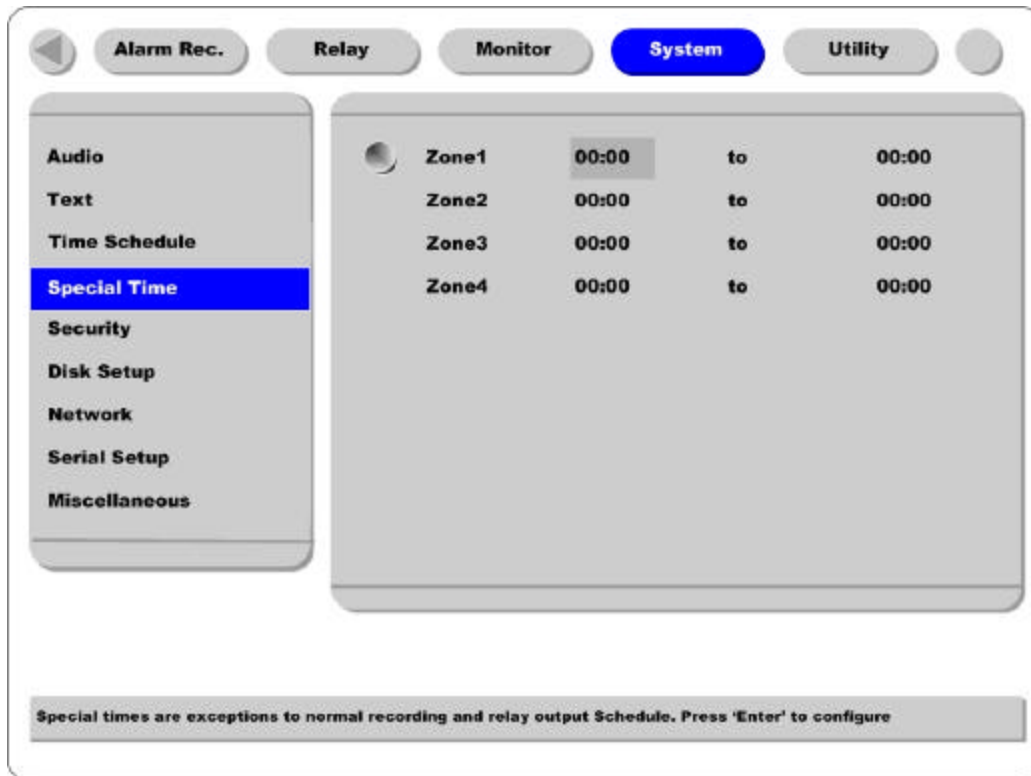

Up to four zones can be designated as "Special Time."

5.7.5. Security

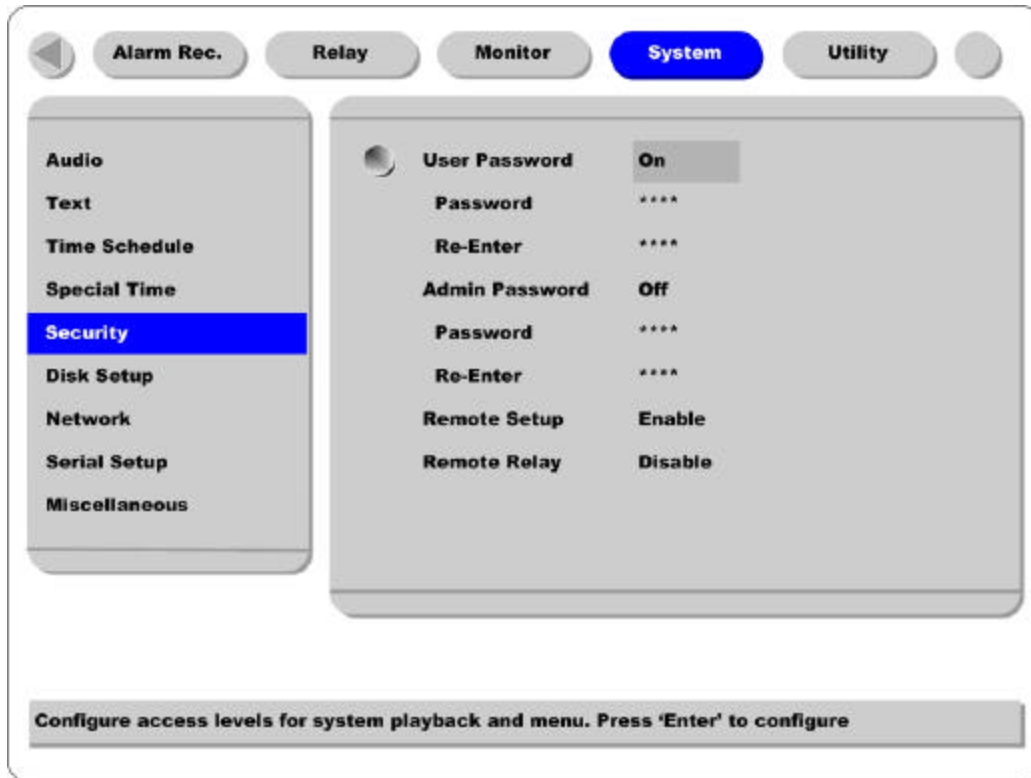

User Password

Designate a User's Password for access to monitoring and playback. Default password is "0000".

Admin Password

Designate an Administrator's Password to control access to Configuration Menu and full system control authority. Default password is "9999".

Remote Setup

When set to "Enable," users can configure ELX8-60 through the S/W interface from a remote site via network.

Remote Relay

Enables access to the "Relay" menu from a remote site.

5.7.6. Disk Setup

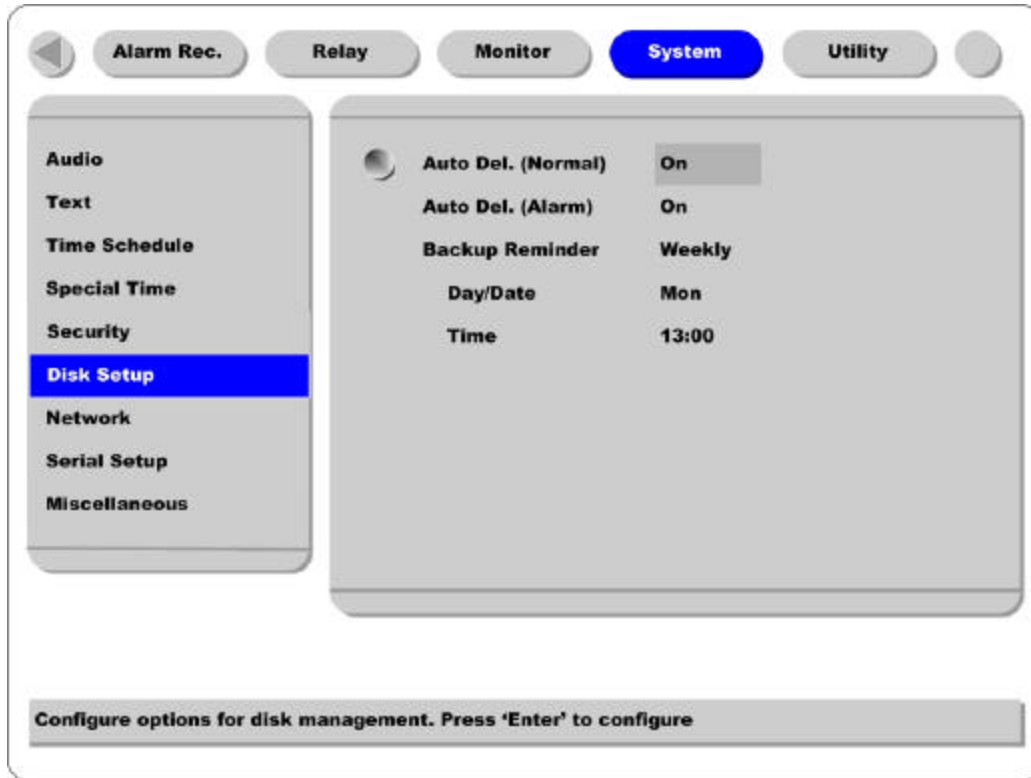

Auto Del. (Normal)

Images and data recorded under the “Normal” condition are automatically deleted as the hard-drive(s) reaches capacity. Images are written over based on a first-in first-out basis. Images recorded based on “Alarm” conditions are not written over.

Auto Del. (Alarm)

If enabled, all images, “Normal” and “Alarm,” will be written over based on a first-in first-out basis.

Backup Reminder

A Backup Reminder can be set to remind users to backup the HDD. The reminder can be set to appear daily, weekly, or monthly.

Day/Date/Time

To set the time for the Backup Reminder.

5.7.7. Network

There are four sub-menus; Network, xDSL, HRS, and Port Setting.

5.7.7.1. Network

This page is to define network type and set network addresses for ELX8-60.

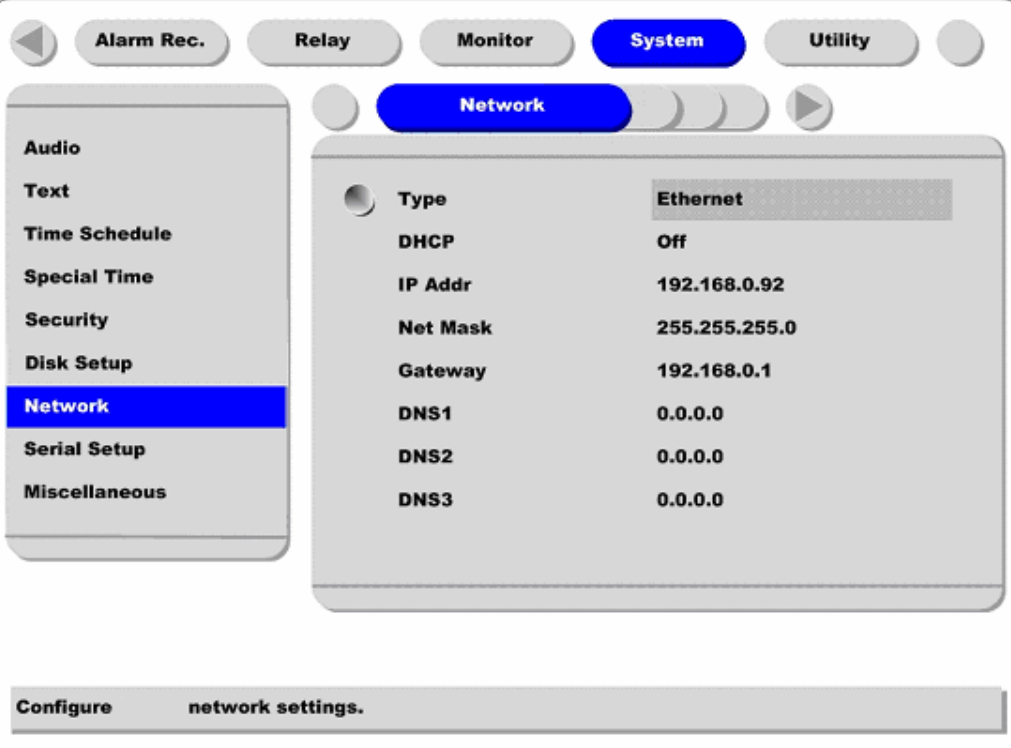

<ul style="list-style-type: none"> Audio Text Time Schedule Special Time Security Disk Setup Network Serial Setup Miscellaneous 	<p>Network</p> <table> <tr> <td><input type="radio"/> Type</td> <td>Ethernet</td> </tr> <tr> <td>DHCP</td> <td>Off</td> </tr> <tr> <td>IP Addr</td> <td>192.168.0.92</td> </tr> <tr> <td>Net Mask</td> <td>255.255.255.0</td> </tr> <tr> <td>Gateway</td> <td>192.168.0.1</td> </tr> <tr> <td>DNS1</td> <td>0.0.0.0</td> </tr> <tr> <td>DNS2</td> <td>0.0.0.0</td> </tr> <tr> <td>DNS3</td> <td>0.0.0.0</td> </tr> </table>	<input type="radio"/> Type	Ethernet	DHCP	Off	IP Addr	192.168.0.92	Net Mask	255.255.255.0	Gateway	192.168.0.1	DNS1	0.0.0.0	DNS2	0.0.0.0	DNS3	0.0.0.0
<input type="radio"/> Type	Ethernet																
DHCP	Off																
IP Addr	192.168.0.92																
Net Mask	255.255.255.0																
Gateway	192.168.0.1																
DNS1	0.0.0.0																
DNS2	0.0.0.0																
DNS3	0.0.0.0																

Configure network settings.

Type

This is to select proper network interface (Ethernet/xDSL) with which ELX8-60 is connected. If ELX8-60 is connected with Internet dedicated line, cable modem line or on LAN environment, select network interface as 'Ethernet.'

If ELX8-60 is connected on xDSL line that needs PPPoE process to connect to the Internet, administrator should select 'xDSL.' However, if the xDSL line does not need PPPoE process, administrator should select 'Ethernet,' even though ELX8-60 is connected on xDSL line.

DHCP

Basically, this menu is for the lines that have Ethernet interfaces such as Internet dedicated line, cable modem line and LAN. If administrator activates 'DHCP' menu, all addresses are set automatically by ELX8-60 detecting them from DHCP server of your ISP. The detected addresses are not displayed on the screen. The addresses do not need to be entered manually unless 'DHCP' is disabled.

DHCP can also be used for xDSL (PPPoE) interface. Sometimes, all computers on a Local Area Network (LAN) share a single Floating / Dynamic IP address. In this case, the ELX8-60 should be assigned a private IP address and have DHCP enabled. Users on the LAN can connect to the ELX8-60 using the private IP address and outside users can connect to the ELX8-60 over the Internet.

IP Address, NetMask, and Gateway Address, DNS

Administrator may configure IP address, subnet mask, gateway address, and DNS addresses of ELX8-60.

DNS Server IP Address

The DNS server address is the address of the RUGGED CCTV Registration Server (HRS). If using dynamic IP registration, the DNS Server IP address should be the address of the HRS, 210.116.114.37.

5.7.7.2. xDSL

If ELX8-60 is connected on xDSL line and needs PPPoE process, the network administrator should configure the user ID and password for PPPoE. ID. The password may be acquired from the ISP that installed the line. Once configured, the ELX8-60 will receive an IP address when it is connected on xDSL line.

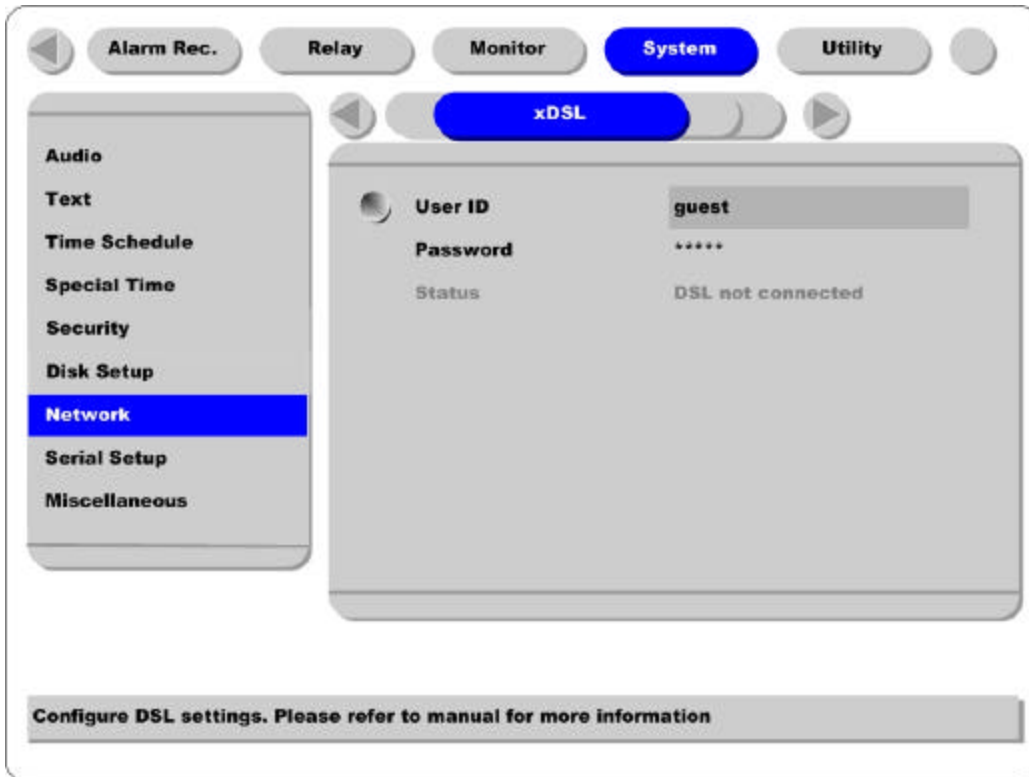

User ID/Password

When ELX8-60 is connected to xDSL, access ID and Password should be entered.

Status

Displays the ELX8-60 connection status.

5.7.7.3. HRS

When a ELX8-60 is installed under the environment of Cable Modem or xDSLModem connection, its IP address changes whenever it reconnects to the Internet Service Provider (the ELX8-60 has a Dynamic or Floating IP address). In this case users who don't know the changed IP address cannot get access to the ELX8-60. ELX8-60 with dynamic IP should be registered to the RUGGED CCTV Registration Server (HRS) server in order to make it easy for users to find the changed IP address, when they want to access the ELX8-60.

To register dynamic IP address to HRS, configure the descriptions below. If using xDSL modem or Cable modem, configuration should be the same.

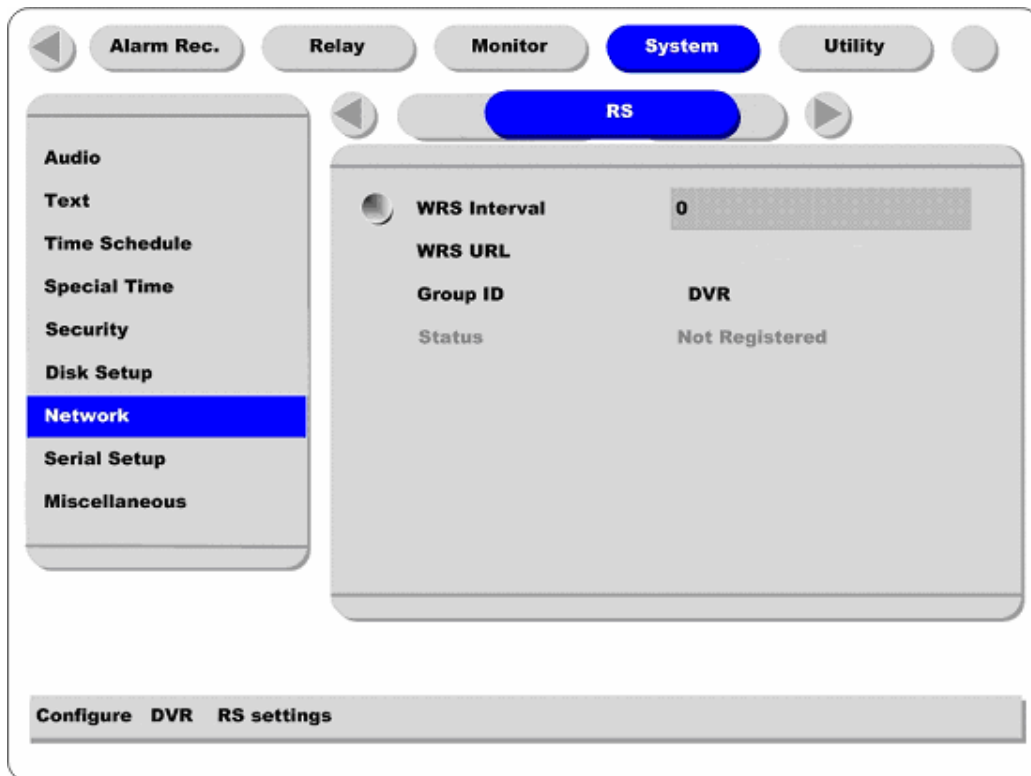

HRS Interval

HRS Interval should be set at 3600 seconds. This designates the frequency the ELX8-60 will update information to the HRS. If the interval is set lower than 3600 seconds, Rugged CCTV cannot guarantee connectivity. If the HRS received too many updates, it may close the connection to the unit. The HRS maintains registered units on the server list for two days. If no signal is received before two days, the HRS will delete the unit from the register.

HRS URL

This is to configure a server address for registration.

Group ID

Group ID is for discriminating and managing the information received by the HRS from the ELX8-60 belonging to group. The group ID should be unique to avoid unauthorized access to the ELX8-60. Unauthorized users will not be able to access the ELX8-60 unless they have a login name and password, but they will be able to see the unit on their registration list.

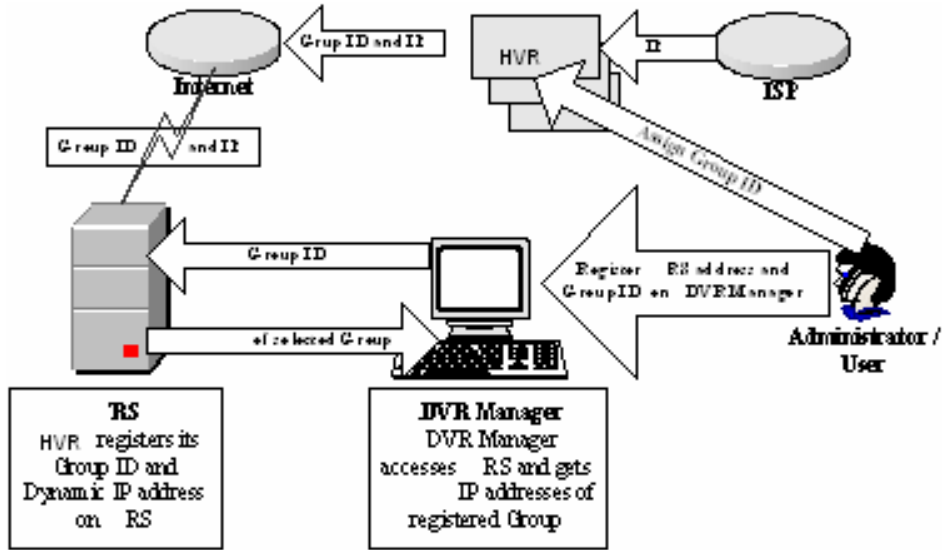

Status

Displays the registration status of the ELX8-60.

5.7.7.4. Port Setting

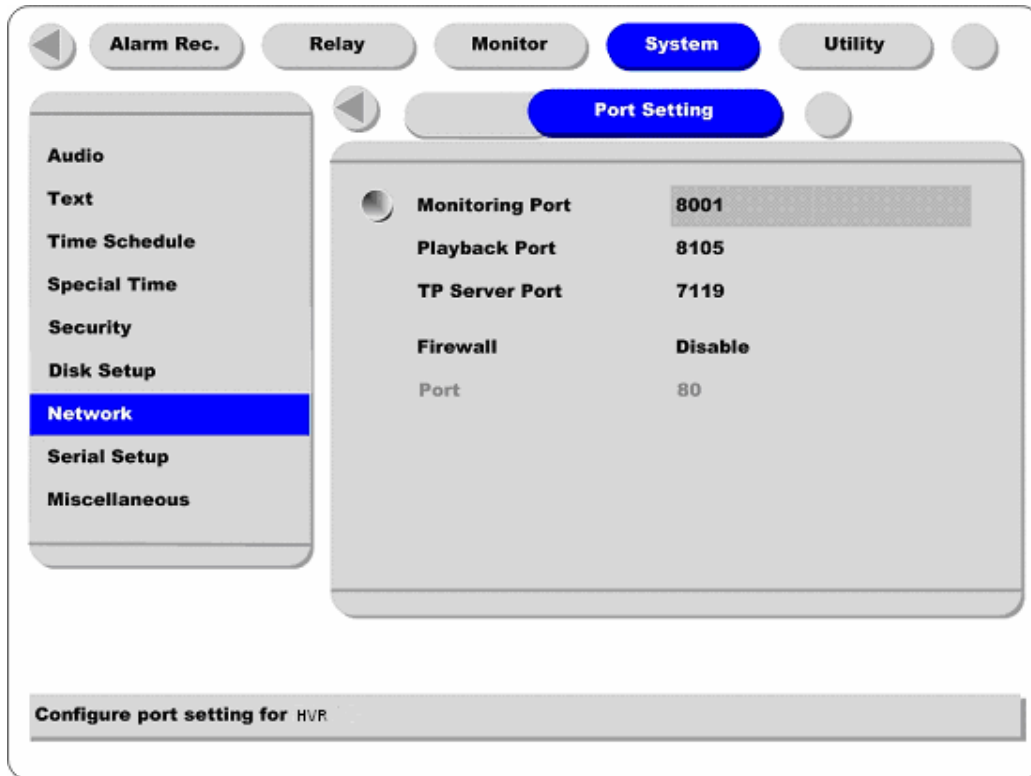
**Monitoring Port / Playback Port**

ELX8-60 uses port 8001 for Monitoring and port 8105 for Playback. To change the port number to an open port (some firewalls and/or ISPs block certain ports), press the [ENTER] button and use the dialogue box.

TP Server Port

The port used for Transparent Protocol server.

Firewall / Port

If there is a firewall on the network and a unique port is available, user may configure the Monitor and Playback ports as one port. In order to change a port, select "Port" menu, and configure a suitable port value.

5.7.7.5. NTP Setting

NTP (Network Time Protocol) makes time of Network devices synchronize. They are composed of a central server for supplying standard time via Network and a client for receiving the synchronized time with connecting the server.

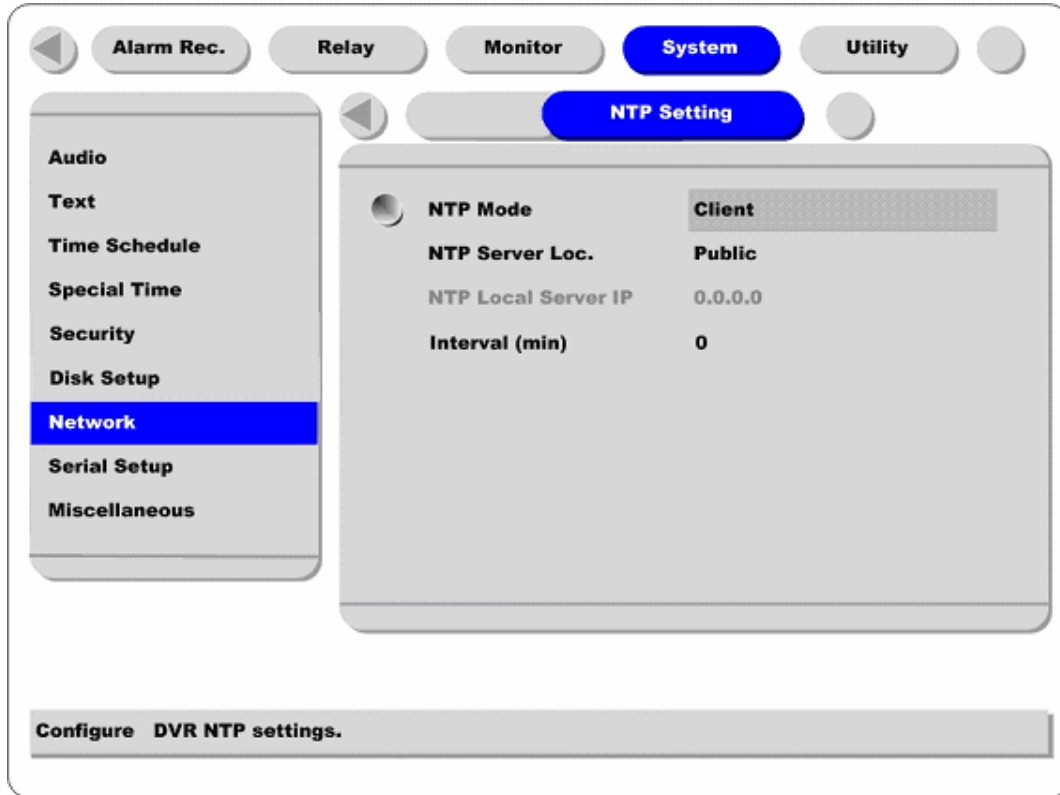

NTP Mode

Set ELX8-60's NTP mode between Client and Server.

NTP Server Loc.

It is possible to set when NTP Mode is set as "Client". Set whether NTP server is on Local Network or Internet (Public).

NTP Local Server IP

It is possible to set when NTP Server Loc. Is set as "Local". Set the server's IP address. Set NTP server's IP address on local Network or the IP address of ELX8-60 that is set as server in NTP mode.

Interval (min)

Set a synchronizing interval.

5.7.8. Serial Setup

There are two RS232 menus (One for external devices connected via the DB-9 pin, and the other for PTZ setting) and one RS 422/485 menu.

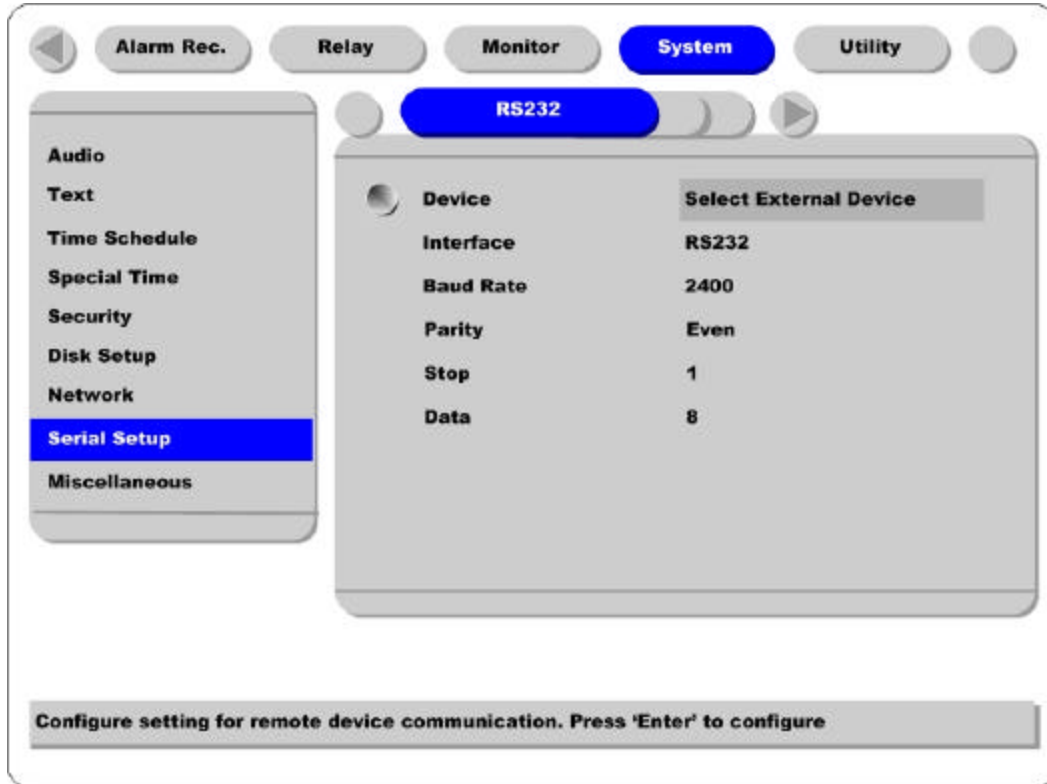

Device

Designate the connected external device.

Interface

Used to designate the protocol on the RS422/RS485 Menu.

Baud rate/Parity/Stop (bit)/Data (bit)

Each value should be set according to the specifications of the connected external device.

5.7.9. Miscellaneous

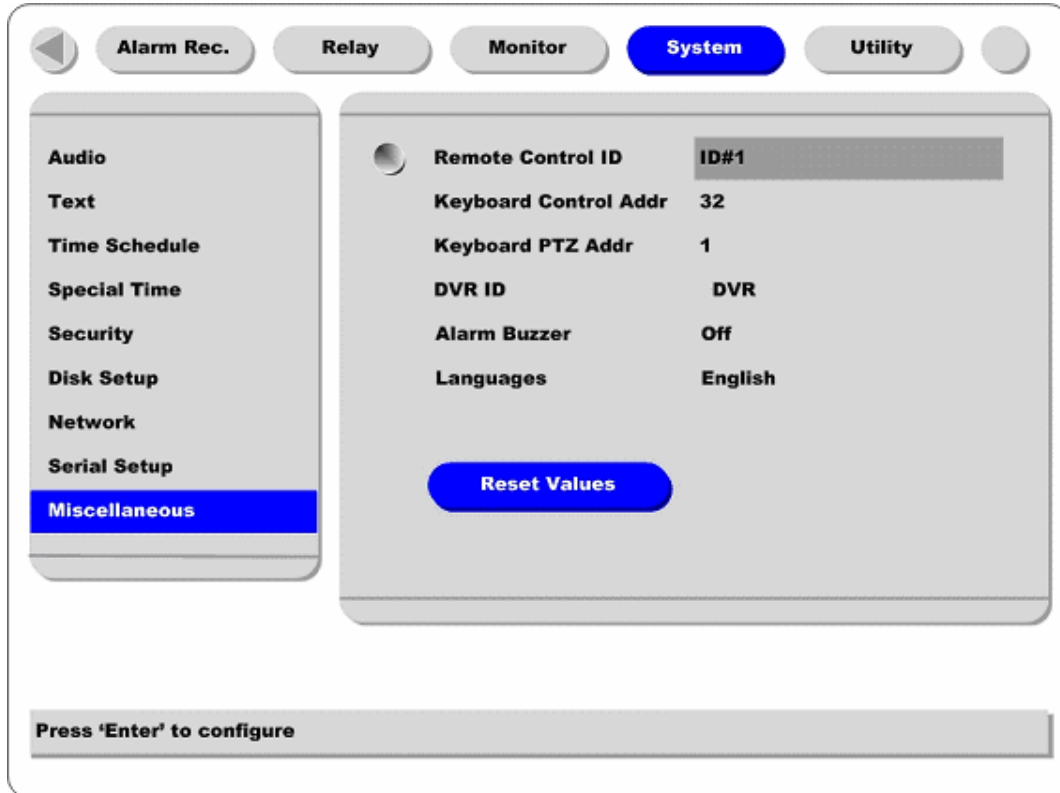

< Button control >

- Press [MENU] button and select “Miscellaneous” below the “System” tab.

Remote Control ID

Up to sixteen ELX8-60s can be controlled with a single IR Remote Control. Designate each unit with a unique number under the ‘Remote Control ID’ menu.

<How to set remote controller>

- Aim remote controller at the ELX8-60.
- Press the “ID” button of remote controller until ELX8-60 reacts.
- If remote controller’s ID agrees with ELX8-60’s, all the LEDs on the front panel of the ELX8-60 will light up and a buzzer will sound.
- OSD menus can now be set with the remote controller.

Keyboard Control Addr

To set keyboard's control address in order to operate all ELX8-60's menus with keyboard. Default value is "32". If several ELX8-60s are connected with one keyboard, it can be collided. Then the default value should be changed.

Keyboard PTZ Addr

To set keyboard's PTZ address in order to operate each PTZ camera with keyboard. If setting just first camera's address of each ELX8-60, another cameras' are designated automatically. For example, 1st ELX8-60 has five cameras and 2nd ELX8-60 has six cameras, keyboard PTA address of 1st ELX8-60 should be set as "1" and one of 2nd ELX8-60 be set as "6". Be cautious that PTZ addressed are assigned to all cameras automatically in spite of non PTZ camera.

DVR ID

For use with the DVR Manager to control and manage several ELX8-60s.

Alarm Buzzer

Enables an alarm buzzer when an alarm (MD or sensor) is triggered.

Language

To select the language used for the OSD Menu.

Reset Values

To reset current configured values. To reset DVR, press the "Reset Values" button.

5.8. Utility

The following description is how to add/format internal or external HDD. ELX8-60 supports various external storages.

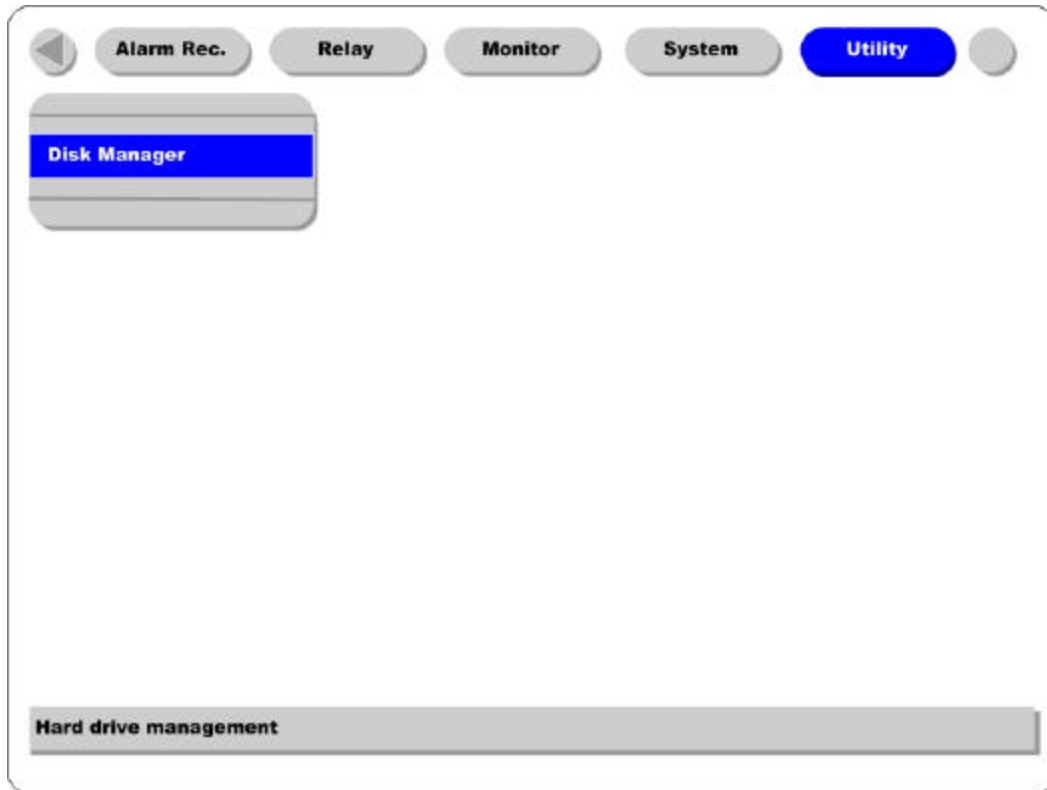

< Button control >

Press [MENU] button and move to "Utility" below the "System" tab.

5.8.1. Disk Manager

A connected HDD is detected automatically.

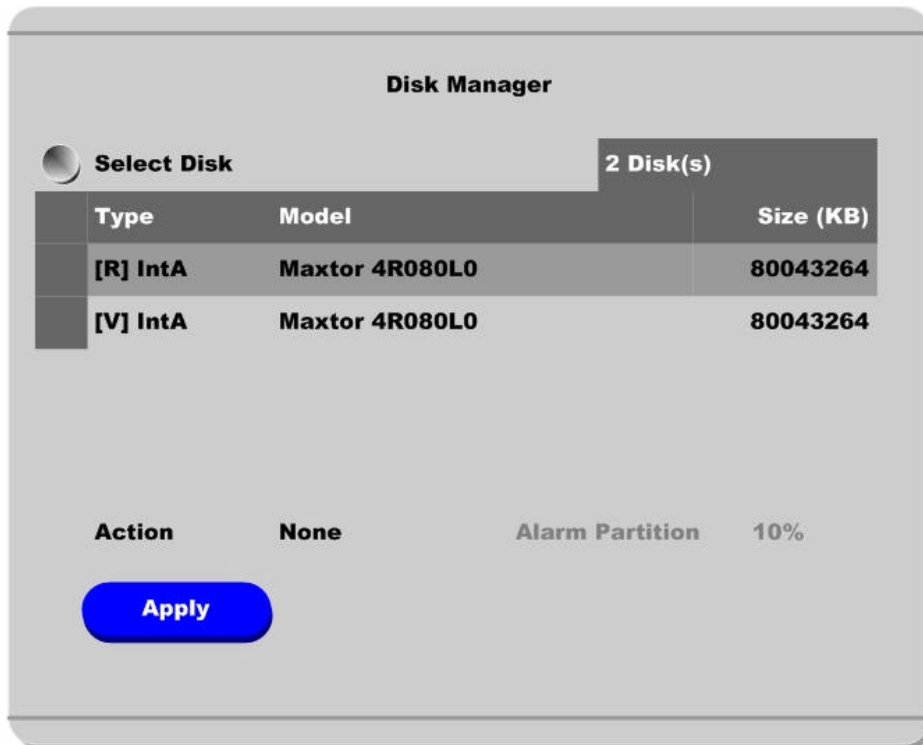

Select Disk

To select a Disk.

Action

Select from “Add/Remove/Format/Confirm Removed/Add used”.

[Format]	Format as ELX8-60's file system. Not available to PC file system.
[Add]	Add HDD for recording. Need to format.
[Add Used]	Add a HDD that has been used and formatted. There is no need to reformat. It is possible only when HDD is added as Primary Disk.
[Remove]	Remove current HDD. HDD can be reused without data loss by the 'Add Used' command.
[Confirm Removed]	Used when a removed HDD is still listed. ALL DATA WILL BE LOST!

Type

There are several symbols to indicate HDD status.

[R] : Available for recording

[V] : Connected and formatted as ELX8-60's file system.

If using 'Add used' command, it will be changed to [R]. There is no need to format again.

[F] : Connected but not available file system. After using 'Add', need to format to make HDD available for recording [R].

[*] : Connected and undergone the 'Add' command. HDD needs to be formatted to be available for recording [R].

[X] : HDD cable is not connected or HDD has a problem. It is recommended to delete from list using 'Confirm Removed'.

Advanced Configuration

6. Connecting External Device

6.1. Using Text Device

In order to use text device, the following four menus should be set; Text menu, Serial Setup's RS232 menu, Alarm Rec. menu, Normal Rec. menu

6.1.1. Setting at Text menu

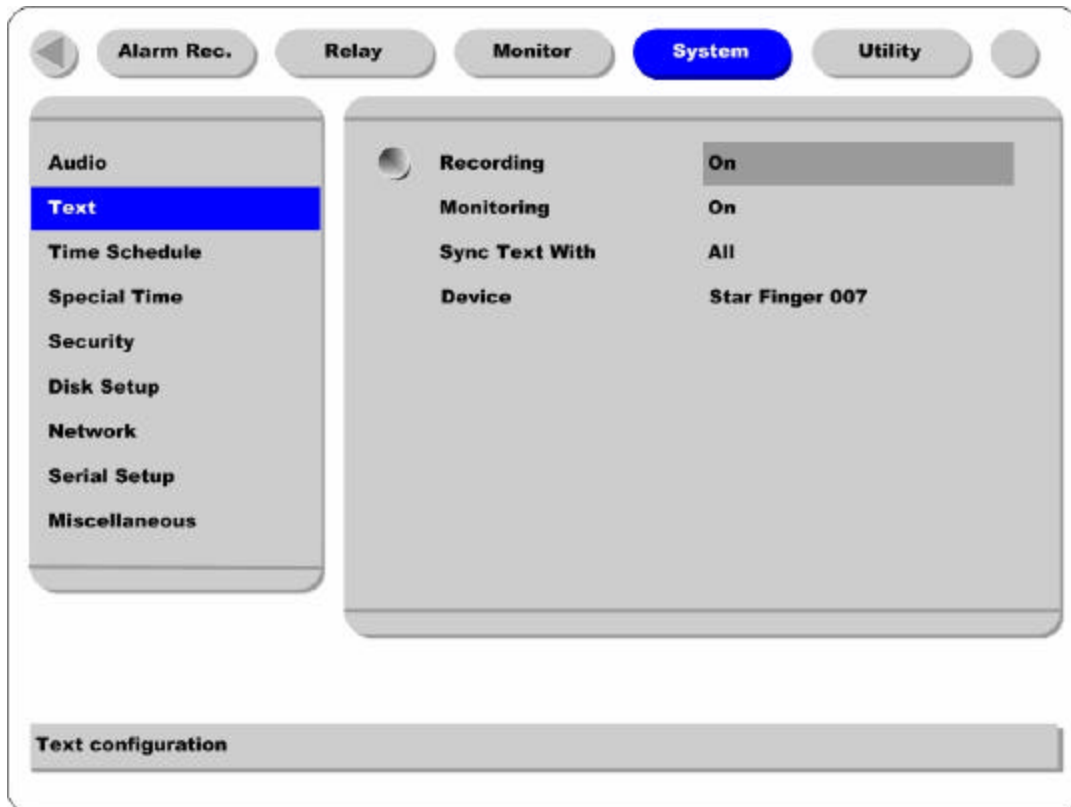

- Set both Recording and Monitoring as "On"
- Set "Sync. Text with" value.
- If the connected device is Star Finger 007, select it at "Device" menu. If not, set "Manual" and each sub-menu.

6.1.2. Setting at Serial Setup's RS232 menu



- Set RS232's device menu as "Text". And set baud rate, parity, stop, and data.

6.1.3. Setting at Alarm Rec. menu



- Set text event as "On".

6.1.4. Setting at Normal Rec. menu

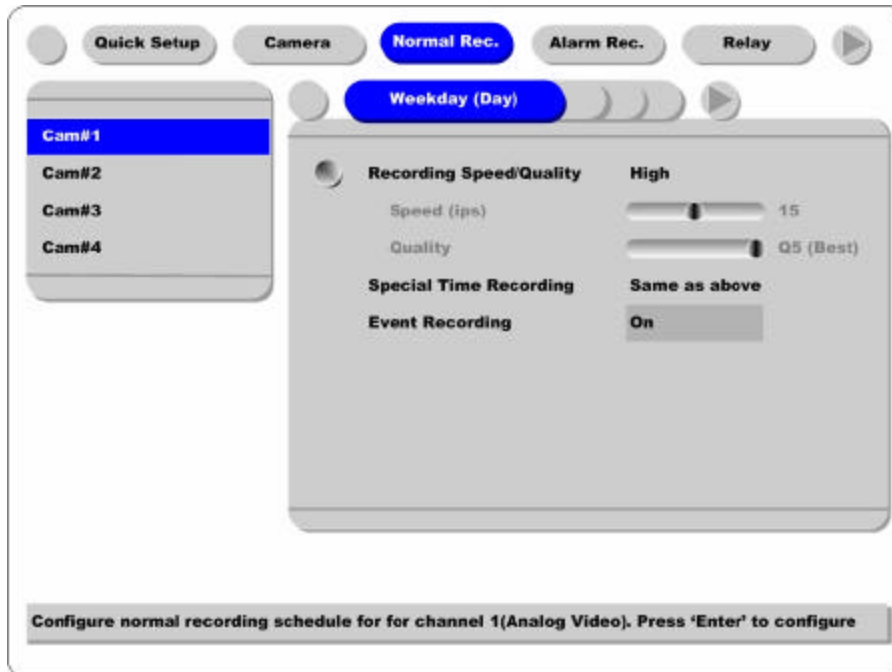

- Set event recording as “On” at each time schedule.

< Note >

Whenever pressing the “Help” button, information of displayed image is different.

The default value of Monitoring mode is to show just channel number. Then next step is to show channel name and text, event status, and HDD status.

The default value of Playback mode is to show all information. The next level is to show channel name and text, event status, and channel number.

So in order to view text data, press the “Help” button once at both Monitoring and Playback modes.

6.2. Using Keyboard

In order to use keyboard, the following two menus should be set; Serial Setup's RS232 menu, Serial Setup's PTZ menu

6.2.1. Setting at Serial Setup's RS232 menu

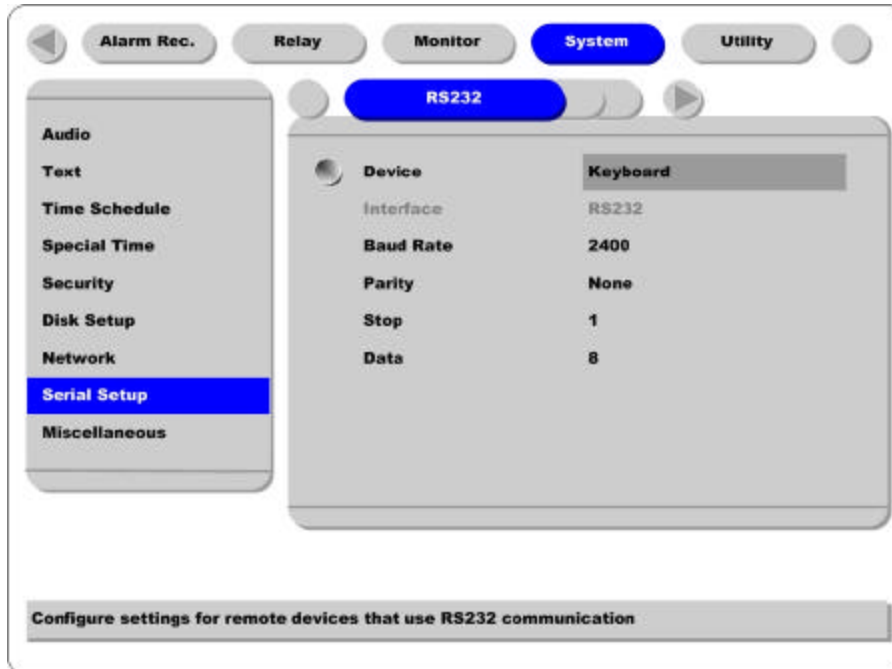

- Set RS232's device menu as "Keyboard". And set baud rate, parity, stop, and data.

6.2.2. Setting at Serial Setup's PTZ menu

- Set PTZ camera to control with keyboard. For more detailed technical solution, please contact the closest local distributor.



APPENDIX

#1. Technical Specification

<i>Hardware</i>	32bit RISC Embedded processor (200MIPS) Flash memory: 8Mbyte RAM: 32Mbyte OS: Embedded Linux
<i>Storage Device</i>	Int.: 2 HDD bays Ext: 3 IEEE 1394 (FireWire) connection ports Supports Disk Management Tool for all disks (Reboot is required when HDD changed) Total manageable capacity: 2 TB
<i>Image Quality Control</i>	5 Levels (Q1-Q5)
<i>Image Compression</i>	Compression Algorithm: Differential Wavelet Compression Rate: 20:1 ~500:1 Average file size: 3 ~ 5KB (Standard Quality)
<i>Video Channel</i>	NTSC or PAL video format are supported 4Ch. analog video inputs via BNC connector
<i>Recording Performance</i> <i>(on 360X243) Analog Ch</i>	Max. 60fps(NTSC) / 50fps(PAL) in total Max 30 fps (NTSC) per channel if 2ch used Max. 15fps (NTSC) per channel if 4ch used
<i>Schedule Recording</i>	Daily: Day / night / Four-segment time frame Weekly: Weekdays / Weekends Status: Normal / Event
<i>Matrix Digital Output Schedule</i>	Daily: Day / night / Four-segment time frame Weekly: Weekdays / Weekends Conditions: MD, sensor input
<i>Configurable Recording Conditions</i>	Recording speed: None to 30 fps Image quality: 5 Levels Event conditions: MD & sensor inputs
<i>Pre / Post Alarm Recording</i>	Pre Alarm Recording: 1 ~ 10 seconds Post Alarm Recording: 1 ~ 60 seconds

<i>Intelligent file system</i>	Data-loss protection against power failure
<i>Event Triggered Video Data Preservation</i>	Overwrite prevention of Event triggered data
<i>Event Log Recording</i>	Log archiving on HDD Log search & monitoring via Network
<i>Data (Video & Audio Clip) Back-up</i>	External HDD: IEEE1394 (FireWire) or USB PnP Memory Stick: USB port
<i>Data Copy (Max. 1 minute's video clip)</i>	VHS Video Tape: Video output port for VCR Backup Notification: Daily / Weekly / Monthly PnP USB storage(Compact Flash, Smart Media, Memory Stick, SD Card)
<i>Displaying Performance</i>	Frame Rate on CCTV Monitor: Max. 120fps Frame Rate on PC: Max. 60ips Display Channel: Quad, Auto Sequential Misc. Play speed: 1x, 2x, 4x, 8x, 16x (FDW & REV) Supports Step-Forward, Step-Reverse. Instant data access based on time and event log
<i>Digital Zoom</i>	2 times digital zoom (Live & Playback Mode)
<i>Event Triggered Pop-up Video</i>	Triggered by motion detection or sensor input
<i>PTZ Control</i>	Ports: RS232, RS485/RS422
<i>Local User</i>	Front panel push button & IR Remote (controls IP video channels as well)
<i>Remote User</i>	On-the-screen PTZ control on PC Preset: 8 points per channel Group: 1 group per channel Return Home Position' support
<i>Sensor Inputs and Alarm Outputs</i>	Software-controlled 4 sensor input s Software-controlled 4 alarms output s

<i>Audio Recording and Playback</i>	Input: 1Ch, line-in, 1Vpp Output: 1Ch, line-out, 1Vpp Level: -7 ~ 8 Recording level control Support 20dB Amp. for low level audio recording Supports local and remote audio monitoring
<i>Network</i>	Protocol: T CP/IP, ARP, ICMP, DHCP, PPPoE Line: 10/100Mbps Ethernet (RJ-45)
<i>Simultaneous User Support over Network</i>	Monitoring: Max. 5 users Playback: Max. 5 users
<i>Management and Firmware Upgrades</i>	Firmware upgrades via Network
<i>Security</i>	Password (User or Administrator Authentication) Watermarking (For image copying)
<i>Power Supply (included)</i>	Input: AC 100~240V, 50~60 Hz Output: DC 12V, 5A
<i>Power Consumption (with 2 HDDs)</i>	Booting: Max. DC 12V \pm 10%, 4.5A (54W) Normal: DC 12V \pm 10%, 3.9A (35W)
<i>Environmental Spec</i>	Operating: 41 ~ 113 degrees F. Storage: -49 ~ 149 degrees F.

#2. Utilizing IP Addresses on Local Network

#2.1 Introduction

Most of our businesses are done via Internet, lately. We play with information by transmitting through e-mails and searching the world of Internet. IP address is what we utilize to access to the Internet.

Currently used IP addresses are limited. And there are 5 classes' networks in the world for now, and a network contains lots of IP addresses. A network can hold limited IP addresses. The numbers depend on network class. 5 classes are from A to E, and the most common one is C class network.

#2.2 IP construction and Network class

1) IP construction

xxx	xxx	xxx	xxx	(xxx: 0 – 255)
X1	X2	X3	X4	

2) Network class

A class: A network that contains IP addresses from 0 to 127 at room 'X1'.

- Network ID: X1
- Host ID: X2, X3, X4
- Total number of A-class networks is 128 in the world.

B class: A network that contains IP addresses from 128 to 191 at room 'X1'.

- Network ID: X1, X2
- Host ID: X3, X4
- Total number of B-class networks is 65,534 in the world.

C class: A network that contains IP addresses from 192 to 223 at room 'X1'.

- Network ID: X1, X2, X3
- Host ID: X4
- It is the most common network in the world, and the total number of C-class networks is 2,097,152

D class A network that contains IP addresses from 224 to 239 at room 'X1'. D-class network is for multicasting, and it is not allowed to use for common users.

E class: A network that contains IP addresses from 240 to 255 at room 'X1'. E-class network is reserved.

#2.3 C-class Network

1) Features of Addresses

IP address: Three digits number in room 'X4' are for Host ID, and the numbers are from 0 to 255. Among the numbers, 0 is used for Network ID, 1 is used for Router IP (Gateway address) and 255 is used for Broadcast address. Therefore the numbers from 2 to 244 are IP addresses that can be assigned to products.

Network ID: It is to identify a network. Generally the first number is assigned as Network ID.

Gateway address: It is an IP address of router that is connecting Internet and local network. Remote users can access local network over Internet through the gateway (router). Generally the second number is assigned as Gateway address.

Broadcast address: It is to broadcast to all devices that are connected on local network. Broadcast address is a destination for broadcasting and it is determined by calculating. All devices connected on local network have a same Broadcast address.

Subnet Mask: It is to divide a local network into two remote networks. Subnet mask shows the IP quantity in a certain network. The numbers that can be used as subnet mask are limited (0, 4, 8, 16, 32, 64, 128)

2) Network configuration

(1) To use as one network

Network ID: xxx.xxx.xxx.0

Gateway Address: xxx.xxx.xxx.1

Subnet Mask: 255.255.255.0

Broadcast Address: xxx.xxx.xxx.255

IP Addresses: xxx.xxx.xxx.2 – xxx.xxx.xxx.254

(2) To use as two sub-networks (1/2 + 1/2)

Sub-Network ID: xxx.xxx.xxx.0

Gateway Address: xxx.xxx.xxx.1

Subnet Mask: 255.255.255.128

Broadcast Address: xxx.xxx.xxx.127

IP Addresses: xxx.xxx.xxx.2 – xxx.xxx.xxx.126

Sub-Network ID: xxx.xxx.xxx.128

Gateway Address: xxx.xxx.xxx.129

Subnet Mask: 255.255.255.128

Broadcast Address: xxx.xxx.xxx.255

IP Addresses: xxx.xxx.xxx.130 – xxx.xxx.xxx.254

(3) To use as three sub-networks (1/4 + 1/4 + 1/2)

Sub-Network ID: xxx.xxx.xxx.0

Gateway Address: xxx.xxx.xxx.1

Subnet Mask: 255.255.255.192

Broadcast Address: xxx.xxx.xxx.63

IP Addresses: xxx.xxx.xxx.2 – xxx.xxx.xxx.62

Sub-Network ID: xxx.xxx.xxx.64

Gateway Address: xxx.xxx.xxx.65

Subnet Mask: 255.255.255.192

Broadcast Address: xxx.xxx.xxx.127

IP Addresses: xxx.xxx.xxx.66 – xxx.xxx.xxx.126

Sub-Network ID: xxx.xxx.xxx.128

Gateway Address: xxx.xxx.xxx.129

Subnet Mask: 255.255.255.128

Broadcast Address: xxx.xxx.xxx.255

IP Addresses: xxx.xxx.xxx.130 – xxx.xxx.xxx.254

(4) To use as four sub-networks (1/4 + 1/4 + 1/4 + 1/4)

Sub-Network ID: xxx.xxx.xxx.0

Gateway Address: xxx.xxx.xxx.1

Subnet Mask: 255.255.255.192

Broadcast Address: xxx.xxx.xxx.63

IP Addresses: xxx.xxx.xxx.2 – xxx.xxx.xxx.62

Sub-Network ID: xxx.xxx.xxx.64

Gateway Address: xxx.xxx.xxx.65

Subnet Mask: 255.255.255.192

Broadcast Address: xxx.xxx.xxx.127

IP Addresses: xxx.xxx.xxx.66 – xxx.xxx.xxx.126

Sub-Network ID: xxx.xxx.xxx.128

Gateway Address: xxx.xxx.xxx.129

Subnet Mask: 255.255.255.192

Broadcast Address: xxx.xxx.xxx.191

IP Addresses: xxx.xxx.xxx.130 – xxx.xxx.xxx.190

Sub-Network ID: xxx.xxx.xxx.192

Gateway Address: xxx.xxx.xxx.193

Subnet Mask: 255.255.255.192

Broadcast Address: xxx.xxx.xxx.255

IP Addresses: xxx.xxx.xxx.194 – xxx.xxx.xxx.254



Rugged CCTV
5327 Cedar Creek Dr.
Kemp, Texas 75143
Tel : (866) 301-2288
Fax : (903) 498-8989

Technical Support: 1-866-301-CCTV
URL: www.rugged-cctv.com
E-mail: sales@rugged-cctv.com